

Comando Remoto RF de roda de toque com regulação

- Compatível com controlador LED de cor única
- Roda digital de ajuste de cores ultra sensível.
- Cada comando pode corresponder a um ou mais receptores.
- Alimentado por bateria AAAx2.
- Funciona com luz indicadora LED.

RT1
1 Zona RegulávelRT6
4 Zona RegulávelRT8
8 Zona Regulável

CE RoHS RED

Parâmetros Técnicos

ENTRADA E SAÍDA		SEGURANÇA E CEM		AMBIENTE	
Sinal de Saída	RF (2.4GHz)	Norma CEM (EMC)	ETSIEN 301 489-1 V2.2.3 ETSIEN 301 489-17 V3.2.4	Temperatura Operacional	Ta: -30 °C ~ +55 °C
Tensão de Trabalho	VDC(AAAx2)	Norma Segurança (LVD)	EN 61347-1:2015+A1:2021 EN 61347-2-13:2014+A1:2017	EMBALAGEM	
Corrente de Trabalho	<5mA	Equipamento Rádio	ETSI EN 300 328 V2.2.2	Tamanho	L140 x W60 x H26mm
Standby current	<10µA	Certificação	CE RED	Peso Bruto	0.088kg
Corrente de Espera	1 ano				
Distância Remota	30m (sem barreiras)				

Instalação e Estruturas Mecânicas

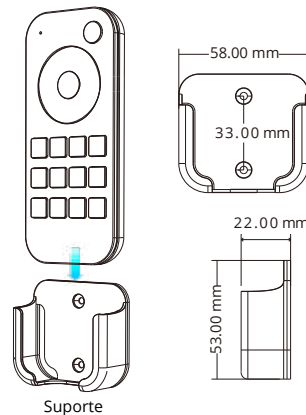
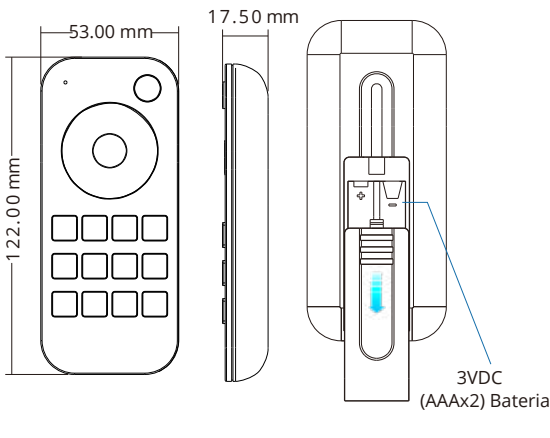

EXISTEM 3 OPÇÕES, PARA FIXAR O COMANDO:

Opção 1: Fixe o comando remoto diretamente em qualquer superfície de metal (ímã).

Opção 2: Fixe o suporte do comando na parede com dois parafusos.

Opção 3: Fixe o suporte do comando na parede com cola.

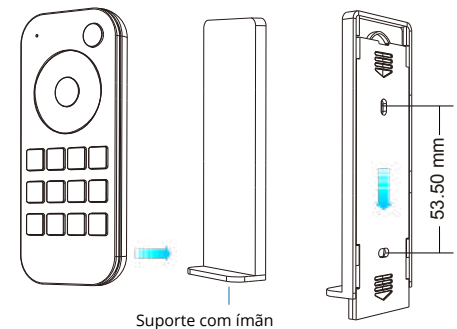

Funcionamento

- Quando a luz ligar, o indicador fica azul. Quando a luz apagar, o indicador fica vermelho.
- Ao tocar na roda de cores, o indicador exibirá a mesma cor
- Quando a função de pressionar ou tocar é inválida (se a luz estiver apagada), o indicador fica vermelho.
- Para prolongar a vida útil da bateria, se não tocar ou pressionar na tecla após alguns segundos, a roda de toque entrará no estado de suspensão, é preciso pressionar qualquer tecla para fazer a roda de toque sair do estado de suspensão

Configurações do comando (duas formas de emparelhar)

O utilizador pode escolher as formas adequadas de emparelhar/desemparelhar. Duas opções são oferecidas para emparelhamento:

Use a tecla de emparelhamento do controlador

Emparelhar:

Pressione rapidamente a tecla de emparelhamento, pressione imediatamente a tecla ligar/desligar (comando de zona única) ou a tecla de zona (comando de zona múltipla) do comando. O indicador LED pisca rapidamente algumas vezes, significa que o emparelhamento foi bem-sucedido.

Desemparelhar:

Pressione e segure a tecla de emparelhamento por 5s para remover todos os emparelhamentos, O indicador LED pisca rapidamente algumas vezes, significa que todos os comandos correspondentes foram desemparelhados.

Usar Reinicialização de Energia

Emparelhar:

Desligue a energia, depois ligue a energia, repita novamente. Pressione imediatamente a tecla ligar/desligar (comando de zona única) ou a tecla de zona (comando de zona múltipla) 3 vezes no comando remoto. A luz pisca 3 vezes, significa que o emparelhamento foi bem-sucedido.

Desemparelhar:

Desligue a energia, depois ligue a energia, repita novamente. Pressione imediatamente a tecla liga/desliga (comando de zona única) ou a tecla de zona (comando de zona múltipla) 5 vezes no comando remoto. A luz pisca 5 vezes significa que todos os comandos remotos correspondentes foram desemparelhados.

Funções do Comando

• RT1-1 zonas de regulação



: Ligar/desligar luz

: Roda para alteração do brilho

: Ajuste o brilho, prima rapidamente 10 níveis, prima longamente 1-6s para um ajuste contínuo de 256 níveis.

: Brilho noturno (10%).

: Temporizador de luz, após 30s, pressione longamente 2s para desligar a luz após 60s.

: 25%, 50%, 75%, 100% brilho.

: Pressione rapidamente para recuperar o cenário, pressione longamente 2s para guardar o brilho atual em S1/2/3/4. O indicador LED fica verde quando guarda OK.

• RT6-4 zonas de regulação

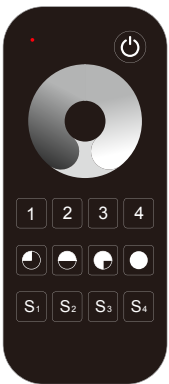

: Pressione rapidamente para ligar/desligar todas as luzes da zona

: Roda para alteração do brilho

: Pressione rapidamente para selecionar e ligue a luz da zona, pressione longamente 2s e pressione rapidamente a tecla de múltiplas zonas rapidamente, irá selecionar várias zonas de forma síncrona

: 25%, 50%, 75%, 100% brilho da zona atualmente selecionada.

: Pressione rapidamente para recuperar o cenário, pressione longamente 2s para guardar o brilho atual em S1/2/3/4. O indicador LED fica verde quando guarda OK. Reconhecimento das 4 zonas ou memorização sincronizada.

O comando pode ser utilizado como controlo de brilho das 4 zonas ou controlo de brilho de 4 canais de zona única.

On/Off + 4 : Pressione 2s para definir o comando como regulador de 4 canais, combine com um ou vários receptores de 4 canais.

On/Off + 1 : Pressione 2s para definir como controlo de regulação de 4 zonas, cada zona corresponde a um ou vários receptores.

Quando ativado, o indicador verde acenderá durante mais tempo.

• RT8-8 zonas de regulação



: Pressione rapidamente para ligar/desligar todas as luzes da zona

: Roda para alteração do brilho

: Pressione rapidamente para selecionar e ligue a luz da zona, pressione longamente 2s e pressione rapidamente a tecla de múltiplas zonas rapidamente, irá selecionar várias zonas de forma síncrona

: Pressione rapidamente para recuperar o cenário, pressione longamente 2s para guardar o brilho atual em S1/2/3/4. O indicador LED fica verde quando guarda OK. Reconhecimento das 4 zonas ou memorização sincronizada.

Informação de Segurança

1. Leia todas as instruções cuidadosamente antes de iniciar esta instalação.

2. Ao instalar a bateria, preste atenção à polaridade positiva e negativa da bateria.

Muito tempo sem usar o comando remoto, remova a bateria.

Quando a distância de funcionamento se tornar menor ou a utilização instável/intermitente, substitua a bateria.

3. Se não houver resposta do receptor, refaça o emparelhamento do comando remoto.

4. Manuseie o comando remoto com cuidado, não deixar cair.

5. Somente para uso interno em local seco.

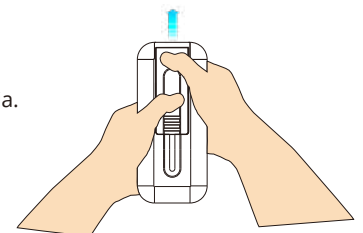

Ao substituir as baterias, utilize as duas mãos para remover a tampa traseira do comando.

Dimming Touch Wheel RF Remote Controller

- Apply to single color LED controller.
- Ultra sensitive color adjustment touch wheel.
- Each remote can match one or more receiver.
- AAAx2 battery powered.
- Operate with LED indicator light.

CE RoHS RED



Technical Parameters

Input and Output		Safety and EMC		Environment	
Output signal	RF(2.4GHz)	EMC standard	ETSI EN 301 489-1 V2.2.3 ETSI EN 301 489-17 V3.2.4	Operation temperature	Ta: -30 °C ~ +55 °C
Working voltage	3VDC(AAAx2)	Safety standard	EN 61347-1:2015+A1:2021 EN 61347-2-13:2014+A1:2017	Package	
Working current	<5mA	Radio Equipment	ETSI EN 300 328 V2.2.2	Size	L140 x W60 x H26mm
Standby current	<10µA	Certification	CE RED	Gross weight	0.088kg
Standby time	1 year			Warranty	
Remote distance	30m(Barrier-free space)			Warranty	5 years

Mechanical Structures and Installations

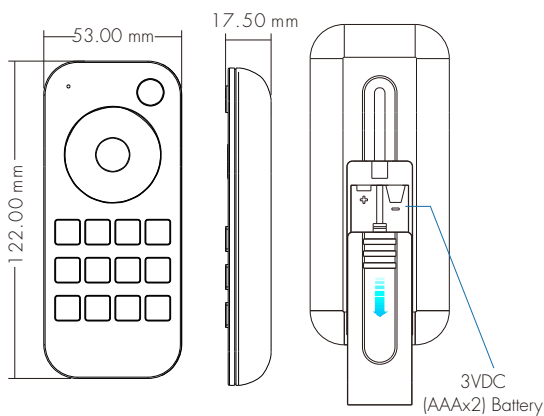

Back holder

Two options are offered for selection, please fix the back holder on the wall with two screws, or adhere the back holder to the wall with paster.

1. Back holder without magnet

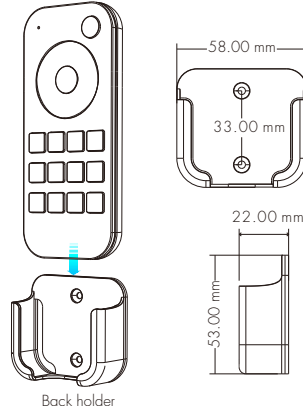

2. Back holder with magnet

(The remote with built-in magnet)

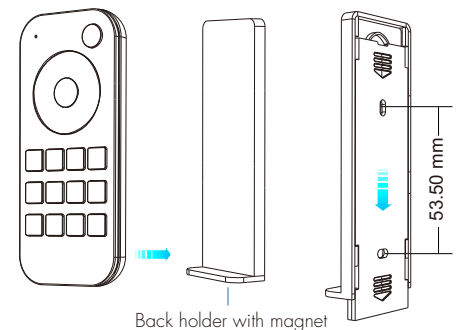

Operation

- When turn on light, the indicator display blue. when turn off light, the indicator display red.
- When touch the color wheel, the indicator will display the same color.
- When press or touch operation is invalid (If the light is off), the indicator display red.
- To extend battery life, no touch or press key operation after a few seconds, the touch wheel will enter sleep state, you need press any key to make touch wheel quit sleep state.

Match Remote Control (two match ways)

End user can choose the suitable match/delete ways. Two options are offered for selection:

Use the controller's Match key

Match:

Short press match key, immediately press on/off key (single zone remote) or zone key (multiple zone remote) of the remote.

The LED indicator fast flash a few times means match is successful.

Delete:

Press and hold match key for 5s to delete all match,

The LED indicator fast flash a few times means all matched remotes were deleted.

Use Power Restart

Match:

Switch off the power, then switch on power, repeat again.

Immediately short press on/off key (single zone remote) or zone key (multiple zone remote) 3 times on the remote.

The light blinks 3 times means match is successful.

Delete:

Switch off the power, then switch on power, repeat again.

Immediately short press on/off key (single zone remote) or zone key (multiple zone remote) 5 times on the remote.

The light blinks 5 times means all matched remotes were deleted.

Key function

● RT1 1 zone dimming remote



 : Turn on/off light.





 : Touch to change brightness.

  : Adjust brightness, short press 10 levels, long press 1-6s for continuous 256 levels adjustment.

 : Small night brightness (10%).

 : Turn off light after 30s, long press 2s will turn off light after 60s.

    : 25%, 50%, 75%, 100% brightness.





    : Short press recall the scene, long press 2s save current brightness into S1/2/3/4. the LED indicator display green when save OK.

● RT6 4 zone dimming remote







 : Short press turn on/off all zone light.

 : Touch to change current zone brightness.

    : Short press select and turn on zone light, long press 2s turn off zone light. Short press multiple zone key fastly, will select multiple zone synchronously.

    : 25%, 50%, 75%, 100% brightness for current selected zone.

    : Short press recall the scene, long press 2s save current state into S1/2/3/4. the LED indicator display green when save OK. 4 zone recall or save synchronously.

The remote can be used as 4 zone dimming remote or single zone 4 channel dimming remote.

On/Off + 4: Long press 2s set as 4 channel dimming remote, only match with one or multiple receiver of 4 channel, such as V4 or C4 controller.

On/Off + 1: Long press 2s set as 4 zone dimming remote, each zone match with one or multiple receivers.





When set ok, the green indicator will light on longer.





● RT8 8 zone dimming remote







 : Short press turn on/off all zone light.

 : Touch to change current zone brightness.

    : Short press select and turn on zone light, long press 2s turn off zone light. Short press multiple zone key fastly, will select multiple zone synchronously.

    : Short press select and turn on zone light, long press 2s turn off zone light. Short press multiple zone key fastly, will select multiple zone synchronously.

    : Short press recall the scene, long press 2s save current state into S1/2/3/4. the LED indicator display green when save OK. 8 zone recall or save synchronously.

Safety information

1. Read all instructions carefully before you begin this installation.
2. When installing battery, pay attention to the battery positive and negative polarity.
A long time without the remote control, remove the battery.
When remote distance becomes smaller and insensitive, replace the battery.
3. If no response from the receiver, please re-match the remote.
4. Gently handle remote, beware of falling.
5. For indoor and dry location use only.

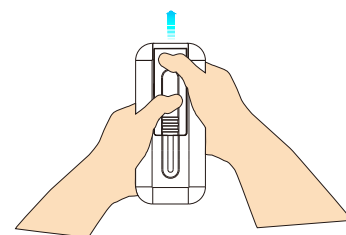

When replacing the batteries, use both hands to remove the back cover of the remote control.