

# Ventiladores

Ventoinhas

2025



**Interlusa**<sup>®</sup>  
Manfred H. Müller & Ca Lda





# **Ventiladores**

*Ventoinhas*

2025



Fundada en mayo de 1967 por Manfred Horst Müller, líder irrefutable y visionario que se destacó por su honesto trabajo y valores. Interlusa creció con una política centrada en el trabajo de las materias primas. Siendo todavía una empresa familiar, se dedica a la importación y reventa de metales, componentes de iluminación y luminarias, además, de la exportación de sus productos al mercado español y PALOPs. Interlusa se ha adaptado constantemente a las necesidades del mercado, ofreciendo a sus clientes las mejores soluciones. Con esta estrategia, Interlusa siempre elige los productos que garantizan la mejor calidad tanto en materiales como en diseño.

Interlusa se destaca por la diversidad de sus líneas, combinando lo moderno con lo clásico y apostando por lámparas con tecnología de última generación, que pone a disposición de sus clientes con la mejor relación calidad/precio. También ofrece una amplia gama de componentes, destinados principalmente a la fabricación de luminarias, así como material eléctrico, sensores, tomas de corriente, extensiones, etc., además de metales como el latón, cobre, zinc, níquel y aluminio en semimanufacturados, como tuberías, pernos, placas, etc., y productos para galvanoplastia como ánodos y alambres de cobre.

*Fundada em maio de 1967 por Manfred Horst Müller, irrefutável líder e visionário, a Interlusa ergueu-se com uma política direcionada ao trabalho das matérias primas. No decorrer dos anos destacou-se pelo seu trabalho honesto e pelos seus valores, sendo até hoje uma empresa familiar. Dedicada à importação e revenda de metais, componentes de iluminação e luminárias, além do mercado interno, também se dedica à exportação dos seus produtos para o mercado espanhol e para os PALOPs. A Interlusa adapta-se constantemente às necessidades do mercado, oferecendo aos seus clientes as melhores soluções. Nessa estratégia, escolhemos sempre os melhores parceiros que garantem a melhor qualidade.*

*A Interlusa destaca-se pela qualidade dos seus materiais e pela diversidade das suas linhas, conjugando o moderno com o clássico. Apostamos em lâmpadas com tecnologia de ponta, garantindo ao cliente a melhor relação preço/qualidade. Oferecemos uma gama alargada de componentes, destinados principalmente ao fabrico de luminárias, bem como material eléctrico, sensores, tomadas, extensões, etc. Fornecemos latão, cobre, zinco, níquel e alumínio em semimanufacturados, tais como tubos, cavilhas, chapas, etc., e produtos para galvanoplastia tais como ânodos e arames de cobre.*

## LUMIT®

LUMIT nace de la experiencia y el compromiso de Interlusa con la iluminación. Se convirtió en un referente del ámbito de la iluminación técnica y decorativa, con 8000 productos activos, distribuidos en Portugal, España, Francia, Reino Unido, Brasil y Angola. Desde los inicios, Lumit ha mantenido el compromiso de calidad y garantía propia de una marca potencial y bien posicionada.

*LUMIT nasce da experiência e do compromisso da Interlusa com a iluminação. Tornou-se numa referência no domínio da iluminação técnica e decorativa, com 8000 produtos ativos, distribuídos em Portugal, Espanha, França, Reino Unido, Brasil e Angola. Desde o começo, manteve o compromisso com a qualidade e a garantia típicas de uma marca de prestígio e bem posicionada.*

*Shakespeare*  
Fantastic Design | Since 1949

SHAKESPEAR es una marca de larga trayectoria en el ámbito de la ventilación doméstica. Desde 1949 se dedica a la fabricación de aparatos de ventilación, adaptados hoy día a las nuevas tecnologías. Su compromiso con la calidad y la rápida respuesta a los nuevos tiempos, hace que trabaje sobre un amplio catálogo de referencias. Actualmente se distribuye en más de cinco países.

*SHAKESPEAR é uma marca com uma longa história no campo da ventilação doméstica. Desde 1949 que se dedica ao fabrico de aparelhos de ventilação, mas sempre adaptados às novas tecnologias. O seu compromisso com a qualidade e a sua ampla resposta aos novos tempos fazem com que trabalhe sobre um vasto catálogo de referências. Atualmente, é distribuída em mais de cinco países.*

# Índice

**Nudos** 20 **N**



**Saturno** 22 **N**



**Almati** 24 **N**



**Akran** 26 **N**



**Ondas** 28 **N**



**Riga** 30 **N**



**Olas** 32 **N**



**Colors** 34 **N**



**Troya** 36 **N**



**Slim** 38



**Antea** 40



**Atlas** 42



# Índice

**Kigali 44**  
+plafón



**Dafne 48**



**Almatea 50**  
+plafón



**Hersa 54**  
+plafón



**Hermes 54**  
+plafón



**Tebe 56**  
+plafón



**Acanto 58**



**Trio 60**



**Toronto 62**



**Quebec 64**



**Arcos 66**



**Sfera 68**



# Índice

**Kepler 70**



**Asgard 72**  
+ mini



**Cosmos 76**  
+ mini



**Alison 80**



**Trébol 83**



**Enebro 84**



**Karla 86**



**Imbat 88**



**Kai 90**



**Tauro 92**   
+ mini



**Mistral 94** 



**Siroco On 96** 



# Índice

**Siroco Off** 98 



**Orion** 100



**Tulum** 102



**Nasim** 104



**Delfos** 106



**Bravo** 108



**Marino** 110



**Poniente** 112



**Kilim** 114

*Shakespeare*  
Fantastic Design Since 1949



**Kenia** 116

*Shakespeare*  
Fantastic Design Since 1949

**Cathay** 118



**Raki Move** 120



# Índice

## Panel 122



## Accesorios 124



## Accesorios 125



















# **Índice de referencias**

*índice de referência*













# Índice

| TAMAÑO<br>TAMANHO | SERIE<br>SÉRIE       |  | REFERENCIA<br>REFERÊNCIA                                      |
|-------------------|----------------------|--|---|
| 132cm L           | <b>Bravo</b>         |     | 200795202B  |
| 132cm L           | <b>Orion</b>         |    | F-1040 WH<br>F-1040 BK  |
| 132cm L           | <b>Nasim</b>         |     | 200295210B  |
| 132cm L           | <b>Delfos</b>        |    | B-2751 WH<br>B-2753 AB<br>B-2752 SN                           |
| 130cm L           | <b>Mistral</b>       |    | B-2546<br>B-2547<br>B-2548                                    |
| 130cm L           | <b>Siroco On</b>     |   | V1021 WH/WO<br>V1021 WH/OAK<br>V1021 BK/WO<br>V1021 BK/OAK    |
| 130cm L           | <b>Siroco Off</b>    |   | V1020 WH/WO<br>V1020 WH/OAK                                   |
| 122cm M           | <b>Marino</b>        |  | 200594801B<br>200594802B<br>200594810B                        |
| 120cm M           | <b>Asgard Maxi</b>   |   | F2005<br>F2006  |
| 120cm M           | <b>Tulum</b>         |  | B-2651WH<br>B-2653SN<br>B-2652BR                              |
| 116cm M           | <b>Poniente</b>      |   | 200394603B  |
| 108cm M           | <b>Antea</b>         |   | F-1027  |
| 108cm M           | <b>Atlas</b>         |   | F-1026  |
| 108cm M           | <b>Kigali+plafón</b> |  | F-3001 WH<br>F-3001 GL<br>F-3001 BR<br>F-3001 SL<br>F-3001 BK |

# Índice

| COLOR<br>COR   | VELOCIDADES<br>VELOCIDADES | MOTOR<br>MOTOR | MODO<br>MODO                            | LUZ<br>LUZ            |
|--|----------------------------|----------------|---|-----------------------|
| Níquel/Madera Níquel/Madeira   | 6                          | DC             | Verano/Invierno <i>Verão/Inverno</i>    | 4000K                 |
| Blanco Branco<br>Negro Preto   | 6                          | DC             | Verano/Invierno<br><i>Verão/Inverno</i> | 3000K   4000K   6000K |
| Plata Prata  | 6                          | DC             | Verano/Invierno <i>Verão/Inverno</i>    | 4000K                 |
| Blanco Branco<br>Cuero/Cerezo Oxidado/Cerejeira<br>Níquel/Haya Níquel/Faia   | 6                          | DC             | Verano/Invierno<br><i>Verão/Inverno</i> | 4000K                 |
| Blanco Branco<br>Blanco/Haya Branco/Faia<br>Negro/Cerezo Preto/Cerejeira   | 6                          | DC             | Verano/Invierno<br><i>Verão/Inverno</i> | 3000K   4000K   6000K |
| Blanco/Haya Branco/Faia<br>Blanco/Roble Branco/Carvalho<br>Negro/Haya Preto /Faia<br>Negro/Haya Preto /Faia                        | 6                          | DC             | Verano/Invierno<br><i>Verão/Inverno</i> | 3000K   4000K   6500K |
| Blanco/Haya Branco/Faia<br>Negro/Haya Preto /Faia  | 6                          | DC             | Verano/Invierno<br><i>Verão/Inverno</i> | 3000K   4000K   6500K |
| Blanco Branco<br>Marrón Castanho<br>Plata Prata  | 6                          | DC             | Verano/Invierno<br><i>Verão/Inverno</i> | 4000K                 |
| Blanco Branco<br>Negro Preto   | 6                          | DC             | Verano/Invierno<br><i>Verão/Inverno</i> | 3000K   4000K   6000K |
| Blanco Branco<br>Blanco/Haya Branco/Faia<br>Marrón Castanhno   | 6                          | DC             | Verano/Invierno<br><i>Verão/Inverno</i> | 3000K   4000K   6000K |
| Níquel Níquel  | 6                          | DC             | Verano/Invierno <i>Verão/Inverno</i>    | 4000K                 |
| Blanco Branco  | 6                          | DC             | Verano/Invierno <i>Verão/Inverno</i>    | 3000K   4000K   6000K |
| Blanco Branco  | 6                          | DC             | Verano/Invierno <i>Verão/Inverno</i>    | 3000K   4000K   6000K |
| Blanco Branco<br>Blanco/Oro Branco/Ouro<br>Blanco/Marrón Branco/Castanho<br>Blanco/Plata Branco/Prata<br>Blanco/Negro Branco/Preto | 6                          | DC             | Verano/Invierno<br><i>Verão/Inverno</i> | 3000K   4000K   6000K |











# Índice

| TAMAÑO<br>TAMANHO | SERIE<br>SÉRIE   |  | REFERENCIA<br>REFERÊNCIA                                      |
|-------------------|------------------|--|---|
| 108cm <b>M</b>    | <b>N</b> Troya   |     | V1008   |
| 108cm <b>M</b>    | Toronto          |     | F-1036  |
| 108cm <b>M</b>    | Quebec           |     | F-1037  |
| 108cm <b>M</b>    | Arcos            |     | F-1010  |
| 108cm <b>M</b>    | Sfera            |    | B-28500WT<br>B-28500SL<br>B-28500GL<br>B-28500BK              |
| 108cm <b>M</b>    | Kepler           |     | F-1028 GL<br>F-1028 SL  |
| 108cm <b>M</b>    | <b>N</b> Nudos   |    | F-1070  |
| 108cm <b>M</b>    | <b>N</b> Saturno |   | F-1071  |
| 108cm <b>M</b>    | Asgard           |  | F1005<br>F1018<br>F1006<br>F1019                              |
| 108cm <b>M</b>    | <b>N</b> Almati  |  | F-1045 WH<br>F-1045 BK<br>F-1045 SL<br>F-1045 GL              |
| 108cm <b>M</b>    | <b>N</b> Ondas   |  | F-1049 WH<br>F-1049 SL<br>F-1049 GL<br>F-1049 BK<br>F-1049 WO |
| 108cm <b>M</b>    | <b>N</b> Colors  |   | F-1038  |
| 108cm <b>M</b>    | <b>N</b> Riga    |  | F-1046 WH<br>F-1046 SL<br>F-1046 GL<br>F-1046 BK              |

# Índice

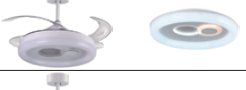
| COLOR<br>COR   | VELOCIDADES<br>VELOCIDADES | MOTOR<br>MOTOR | MODO<br>MODO                            | LUZ<br>LUZ                |
|--|----------------------------|----------------|---|---------------------------|
| Blanco Branco  | 6                          | DC             | Verano/Invierno<br><i>Verão/Inverno</i> | 3000K   4000K   6000K     |
| Blanco Branco  | 6                          | DC             | Verano/Invierno <i>Verão/Inverno</i>    | 3000K   4000K   6000K     |
| Blanco Branco  | 6                          | DC             | Verano/Invierno <i>Verão/Inverno</i>    | 3000K   4000K   6000K     |
| Blanco Branco  | 6                          | DC             | Verano/Invierno <i>Verão/Inverno</i>    | 3000K   4000K   6000K     |
| Blanco Branco<br>Plata Prata<br>Dorado Dourado<br>Negro Preto  | 6                          | DC             | Verano/Invierno<br><i>Verão/Inverno</i> | 3000K   4000K   6000K     |
| Oro Ouro<br>Plata Prata  | 6                          | DC             | Verano/Invierno<br><i>Verão/Inverno</i> | 3000K   4000K   6000K     |
| Blanco Branco  | 6                          | DC             | Verano/Invierno<br><i>Verão/Inverno</i> | 3000K   4000K   6000K     |
| Blanco Branco  | 6                          | DC             | Verano/Invierno<br><i>Verão/Inverno</i> | 3000K   4000K   6000K     |
| Blanco Branco<br>Níquel Níquel<br>Negro Preto<br>Cuero Oxidado   | 6                          | DC             | Verano/Invierno<br><i>Verão/Inverno</i> | 3000K   4000K   6000K     |
| Blanco Branco<br>Blanco/Negro-Oro Branco/Preto-Ouro<br>Blanco/Plata Branco/Prata<br>Blanco/Oro Branco/Ouro                                 | 6                          | DC             | Verano/Invierno<br><i>Verão/Inverno</i> | 3000K   4000K   6000K     |
| Blanco/Blanco Branco/Branco<br>Blanco/Plata Branco/Prata<br>Blanco/Oro Branco/Ouro<br>Blanco/Negro Branco/Preto<br>Blanco/Haya Branco/Faia | 6                          | DC             | Verano/Invierno<br><i>Verão/Inverno</i> | 3000K   4000K   6000K     |
| Blanco Branco  | 6                          | DC             | Verano/Invierno <i>Verão/Inverno</i>    | 3000K   4000K   6000K+RGB |
| Blanco Branco<br>Blanco/Plata Branco/Prata<br>Blanco/Oro Branco/Ouro<br>Blanco/Negro Branco/Preto  | 6                          | DC             | Verano/Invierno<br><i>Verão/Inverno</i> | 3000K   4000K   6000K     |















# Índice

| TAMAÑO<br>TAMANHO | SERIE<br>SÉRIE |  | REFERENCIA<br>REFERÊNCIA                                      |
|-------------------|----------------|--|---|
| 108cm <b>M</b>    | <b>Trío</b>    |     | B-28500WH   |
| 108cm <b>M</b>    | <b>N Ondas</b> |    | F-1039 WH<br>F-1039 SL<br>F-1039 GL<br>F-1039 CO<br>F-1039 BK |
| 108cm <b>M</b>    | <b>N Akran</b> |    | F-1047 BK<br>F-1047 SL<br>F-1047 GL<br>F-1047 BK              |
| 108cm <b>M</b>    | <b>Dafne</b>   |     | F-1015<br>F-1017  |
| 108cm <b>M</b>    | <b>Acanto</b>  |    | F-1029 GL<br>F-1029 SL  |
| 108cm <b>M</b>    | <b>Amaltea</b> |   | F-1032  |
| 108cm <b>M</b>    | <b>Hersa</b>   |   | F-1033  |
| 108cm <b>M</b>    | <b>Hermes</b>  |   | F-1030  |
| 108cm <b>M</b>    | <b>Tebe</b>    |   | F-1031  |
| 107cm <b>M</b>    | <b>Kilim</b>   |  | B 2551 WH<br>B 2553 SN<br>B 2552 SV                           |
| 107cm <b>M</b>    | <b>Kenia</b>   |  | B 2554 WH<br>B 2556 AB<br>B 2555 SV                           |
| 106cm <b>M</b>    | <b>Slim</b>    |  | F-1035<br>F-1035 BK<br>F-1035 WO                              |

# Índice

| COLOR<br><i>COR</i>  | VELOCIDADES<br><i>VELOCIDADES</i> | MOTOR<br><i>MOTOR</i> | MODO<br><i>MODO</i>                     | LUZ<br><i>LUZ</i>     |
|--|-----------------------------------|-----------------------|---|-----------------------|
| Blanco Branco  | 6                                 | DC                    | Verano/Invierno <i>Verão/Inverno</i>    | 3000K   4000K   6000K |
| Blanco/Blanco Branco/Branco<br>Blanco/Plata Branco/Prata<br>Blanco/Oro Branco/Ouro<br>Blanco/Cobre Branco/Cobre<br>Blanco/Negro Branco/Preto | 6                                 | DC                    | Verano/Invierno<br><i>Verão/Inverno</i> | 3000K   4000K   6000K |
| Blanco/Blanco Branco/Branco<br>Blanco/Plata Branco/Prata<br>Blanco/Oro Branco/Ouro<br>Blanco/Negro Branco/Preto                              | 6                                 | DC                    | Verano/Invierno<br><i>Verão/Inverno</i> | 3000K   4000K   6000K |
| Blanco Branco<br>Negro Preto   | 6                                 | DC                    | Verano/Invierno<br><i>Verão/Inverno</i> | 3000K   4000K   6000K |
| Oro Ouro<br>Plata Prata  | 6                                 | DC                    | Verano/Invierno<br><i>Verão/Inverno</i> | 3000K   4000K   6000K |
| Blanco Branco  | 6                                 | DC                    | Verano/Invierno <i>Verão/Inverno</i>    | 3000K   4000K   6000K |
| Blanco Branco  | 6                                 | DC                    | Verano/Invierno <i>Verão/Inverno</i>    | 3000K   4000K   6000K |
| Blanco Branco  | 6                                 | DC                    | Verano/Invierno <i>Verão/Inverno</i>    | 3000K   4000K   6000K |
| Blanco Branco  | 6                                 | DC                    | Verano/Invierno <i>Verão/Inverno</i>    | 3000K   4000K   6000K |
| Blanco Branco<br>Níquel Níquel<br>Plata Prata  | 6                                 | DC                    | Verano/Invierno<br><i>Verão/Inverno</i> | 3000K   4000K   6000K |
| Blanco Branco<br>Cuero Oxidado<br>Plata Prata  | 6                                 | DC                    | Verano/Invierno<br><i>Verão/Inverno</i> | 3000K   4000K   6000K |
| Blanco Branco<br>Negro Preto<br>Blanco/Haya Branco/Faia  | 6                                 | DC                    | Verano/Invierno<br><i>Verão/Inverno</i> | 3000K   4000K   6000K |

# Índice

| TAMAÑO<br>TAMANHO | SERIE<br>SÉRIE     |   | REFERENCIA<br>REFERÊNCIA                                      |
|-------------------|--------------------|---|---|
| 91cm <b>S</b>     | <b>Kigali mini</b> |   | F-3002 WH<br>F-3002 GL<br>F-3002 BR<br>F-3002 SL<br>F-3002 BK |
| 91cm <b>S</b>     | <b>Asgard mini</b> |    | F1005-40<br>F1006-40  |
| 91cm <b>S</b>     | <b>Cosmos mini</b> |    | B-28400WO-40<br>B-28400BK-40                                  |
| 85cm <b>S</b>     | <b>N Tauro</b>     |   | B-2543<br>B-2544<br>B-2545                                    |
| 70cm <b>S</b>     | <b>Tauro mini</b>  |  | B-2540<br>B-2541<br>B-2542                                    |
| 63cm <b>S</b>     | <b>Alison</b>      |  | F-1060  |
| 65cm <b>S</b>     | <b>Karla</b>       |  | F-1062  |
| 65cm <b>S</b>     | <b>Trebol</b>      |  | F-1061  |
| 65cm <b>S</b>     | <b>Imbat</b>       |  | 202296302   |
| 60cm <b>S</b>     | <b>Kai</b>         |  | 202396001   |
| 60cm <b>S</b>     | <b>Panel</b>       |  | DG-8598 LUZ<br>BPC-60   |
| 53cm <b>S</b>     | <b>Enebro</b>      |  | F-1063-WH<br>F-1063-BK  |
| 50cm <b>S</b>     | <b>Cathay</b>      |  | B28170WO  |
| 48cm <b>S</b>     | <b>Raki Move</b>   |  | B-28210   |



# Índice

| COLOR<br>COR   | VELOCIDADES<br>VELOCIDADES | MOTOR<br>MOTOR | MODO<br>MODO                            | LUZ<br>LUZ                     |
|--|----------------------------|----------------|---|--------------------------------|
| Blanco Branco<br>Blanco/Oro Branco/Ouro<br>Blanco/Marrón Branco/Castanho<br>Blanco/Plata Branco/Prata<br>Blanco/Negro Branco/Preto | 6                          | DC             | Verano/Invierno<br><i>verão/Inverno</i> | 3000K   4000K   6000K          |
| Blanco Branco<br>Negro Preto   | 6                          | DC             | Verano/Invierno<br><i>verão/Inverno</i> | 3000K   4000K   6000K          |
| Blanco/Haya Branco/Faia<br>Negro/Haya Preto/Faia   | 6                          | DC             | Verano/Invierno<br><i>verão/Inverno</i> | 3000K   4000K   6000K          |
| Blanco Branco<br>Blanco/Haya Branco/Faia<br>Negro/Cerezo Preto/Cerejeira   | 6                          | DC             | Verano/Invierno<br><i>Verão/Inverno</i> | 3000K   4000K   6000K          |
| Blanco Branco<br>Blanco/Haya Branco/Faia<br>Negro/Cerezo Preto/Cerejeira   | 6                          | DC             | Verano/Invierno<br><i>Verão/Inverno</i> | 3000K   4000K   6000K          |
| Blanco Branco  | 6                          | DC             | Verano/Invierno <i>Verão/Inverno</i>    | 3000K   4000K   6000K          |
| Blanco Branco  | 6                          | DC             | Verano/Invierno <i>Verão/Inverno</i>    | 3000K   4000K   6000K          |
| Blanco Branco  | 6                          | DC             | Verano/Invierno <i>Verão/Inverno</i>    | 3000K   4000K   6000K          |
| Marrón Castanho  | 6                          | DC             | Verano/Invierno<br><i>Verão/Inverno</i> | 3000K   4000K   6000K          |
| Blanco Branco  | 6                          | DC             | Verano/Invierno <i>Verão/Inverno</i>    | 3000K   4000K   6000K          |
| Blanco Branco<br>Blanco Branco   | 3                          | AC             | Verano/ <i>Verão</i>                    | 3000K   4000K   6000K<br>- - - |
| Blanco Branco<br>Negro Preto   | 6                          | DC             | Verano/Invierno<br><i>Verão/Inverno</i> | 3000K   4000K   6000K          |
| Blanco/Madera Branco/Madeira   | 6                          | DC             | Verano/Invierno <i>Verão/Inverno</i>    | 3000K   4000K   6000K          |
| Blanco Branco  | 6                          | DC             | Verano/Invierno<br><i>Verão/Inverno</i> | 3000K   4000K   6000K          |



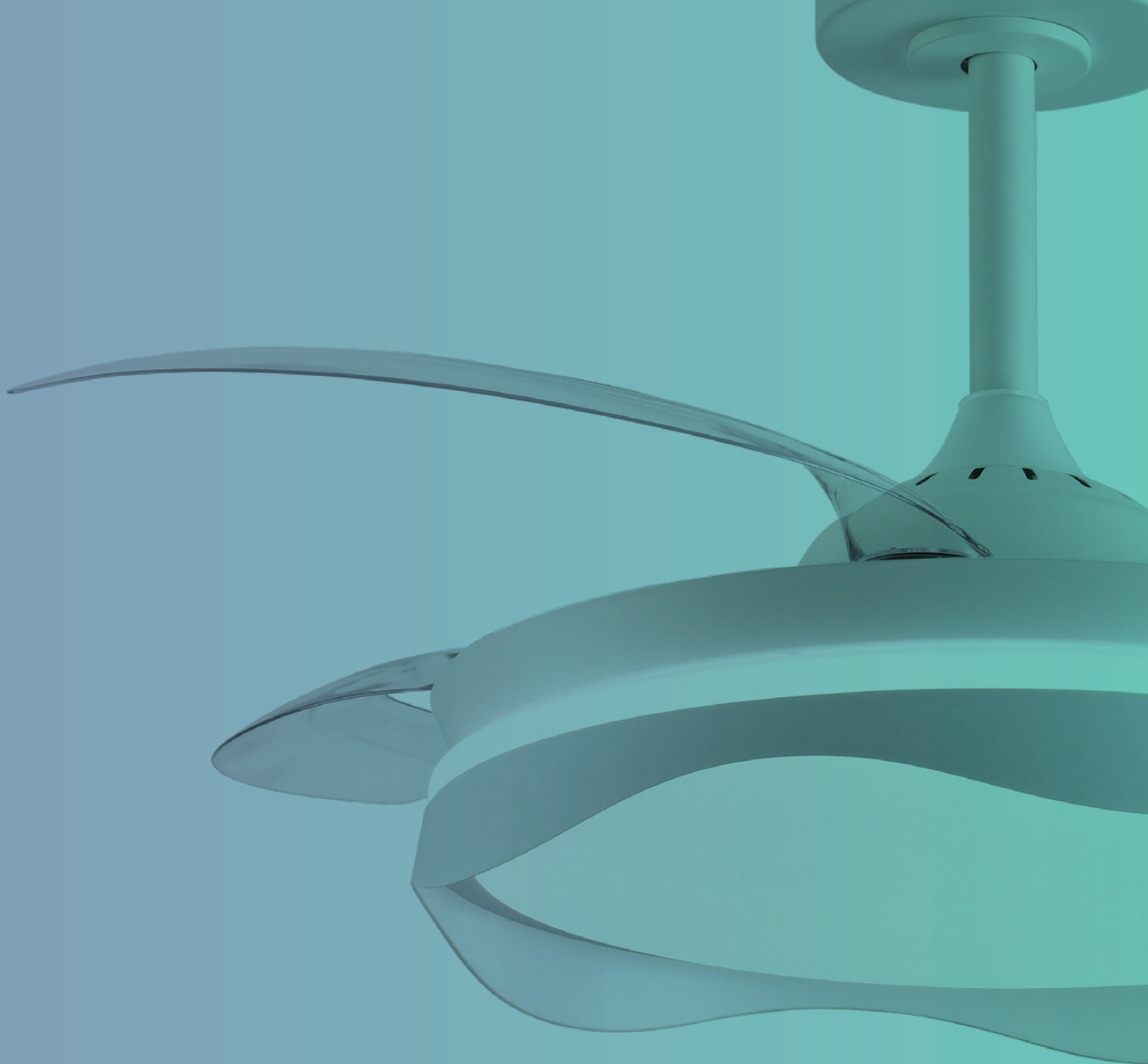

# **Ventiladores retráctiles**

*Ventoinhas com pás retráteis*

**1**



# Nudos

retráctil



REF. F-1070 | Blanco Branco

## + INFO

- Acrílico + Metal+Metacrilato+Policarbonato
- 1/2/4h
- 4 aspas retráctiles *palas retrácteis*

|  | 1                  | 2                  | 3                  | 4                  | 5                  | 6                  | LED                   |
|--|--------------------|--------------------|--------------------|--------------------|--------------------|--------------------|-----------------------|
| CONSUMO<br><small>Consumo</small>        | 6,2W               | 8,5W               | 10,8W              | 15,5W              | 20,8W              | 25,2W              | 200W                  |
| RPM<br><small>RPM</small>                | 175rpm             | 186rpm             | 202rpm             | 215rpm             | 225rpm             | 241rpm             | 16000lm               |
| FLUJO AIRE<br><small>Flujo de ar</small> | 3754m <sup>3</sup> | 4803m <sup>3</sup> | 6336m <sup>3</sup> | 7665m <sup>3</sup> | 8848m <sup>3</sup> | 9953m <sup>3</sup> | 230 V ~ 50 Hz         |
| RUJIDO<br><small>Ruido</small>           | 26dB               | 29dB               | 32dB               | 35dB               | 39dB               | 41dB               | 3000K   4000K   6000K |

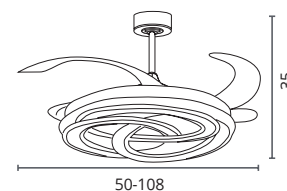







# Saturno





retráctil



REF. F-1071 | Blanco *Branco*

## + INFO

-  Acrílico + Metal+Metacrilato+Policarbonato
-  1/2/4h
-  4 aspas retráctiles *palas retráteis*

|  | 1                  | 2                  | 3                  | 4                  | 5                  | 6                  | LED   |
|--|--------------------|--------------------|--------------------|--------------------|--------------------|--------------------|---|
| CONSUMO<br><i>Consumo</i>  | 6,2W               | 8,5W               | 10,8W              | 15,5W              | 20,8W              | 25,2W              |  200W                  |
| RPM<br><i>RPM</i>  | 175rpm             | 186rpm             | 202rpm             | 215rpm             | 225rpm             | 241rpm             |  16000lm               |
| FLUJO AIRE<br><i>Flujo de ar</i>   | 3754m <sup>3</sup> | 4803m <sup>3</sup> | 6336m <sup>3</sup> | 7665m <sup>3</sup> | 8848m <sup>3</sup> | 9953m <sup>3</sup> |  230 V ~ 50 Hz         |
| RUJIDO<br><i>Ruído</i>   | 26dB               | 29dB               | 32dB               | 35dB               | 39dB               | 41dB               |  3000K   4000K   6000K |

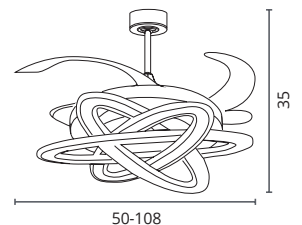







# Almati

retráctil



REF. F-1045 BK | Blanco/Negro-Oro  
Branco/Preto-Ouro

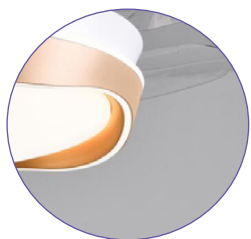

REF. F-1045 WH | Blanco/Blanco  
Branco/Branco



REF. F-1045 SL | Blanco/Plata  
Branco/Prata



REF. F-1045 GL | Blanco/Oro  
Branco/Ouro

**i** Difusor con perfiles iluminados  
Difusor com perfis iluminados

+ INFO

Acrílico + Metal+Metacrilato+Policarbonato

1/2/4h

4 aspas retráctiles *palas retráteis*

|                                  | 1                  | 2                  | 3                  | 4                  | 5                  | 6                  | LED                   |
|----------------------------------|--------------------|--------------------|--------------------|--------------------|--------------------|--------------------|-----------------------|
| CONSUMO<br><i>Consumo</i>        | 6,2W               | 8,5W               | 10,8W              | 15,5W              | 20,8W              | 25,2W              | 72W                   |
| RPM<br><i>RPM</i>                | 175rpm             | 186rpm             | 202rpm             | 215rpm             | 225rpm             | 241rpm             | 6480lm                |
| FLUJO AIRE<br><i>Flujo de ar</i> | 3754m <sup>3</sup> | 4803m <sup>3</sup> | 6336m <sup>3</sup> | 7665m <sup>3</sup> | 8848m <sup>3</sup> | 9953m <sup>3</sup> | 230 V ~ 50 Hz         |
| RUJIDO<br><i>Ruído</i>           | 26dB               | 29dB               | 32dB               | 35dB               | 39dB               | 41dB               | 3000K   4000K   6000K |

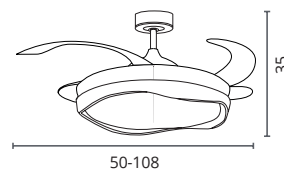



# Akran

retráctil



REF. F-1047 BK | Blanco/Negro  
Branco/Preto



REF. F-1047 WH | Blanco/Blanco  
Branco/Branco











REF. F-1047 GL | Blanco/Oro  
Branco/Ouro



REF. F-1047 SL | Blanco/Plata  
Branco/Prata

## + INFO

-  Acrílico + Metal+Metacrilato+Policarbonato
-  1/2/4h
-  4 aspas retráctiles *palas retráteis*

|  | 1                  | 2                  | 3                  | 4                  | 5                  | 6                  | LED   |
|--|--------------------|--------------------|--------------------|--------------------|--------------------|--------------------|---|
| CONSUMO<br><i>Consumo</i>  | 6,2W               | 8,5W               | 10,8W              | 15,5W              | 20,8W              | 25,2W              |  72W                   |
| RPM<br><i>RPM</i>  | 175rpm             | 186rpm             | 202rpm             | 215rpm             | 225rpm             | 241rpm             |  6480lm                |
| FLUJO AIRE<br><i>Flujo de ar</i>   | 3754m <sup>3</sup> | 4803m <sup>3</sup> | 6336m <sup>3</sup> | 7665m <sup>3</sup> | 8848m <sup>3</sup> | 9953m <sup>3</sup> |  230 V ~ 50 Hz         |
| RUJIDO<br><i>Ruído</i>   | 26dB               | 29dB               | 32dB               | 35dB               | 39dB               | 41dB               |  3000K   4000K   6000K |

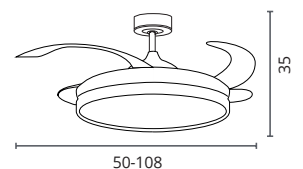





# Ondas

retráctil



REF. F-1039 CO | Branco/Cobre  
Branco/Cobre



REF. F-1039 GL | Branco/Oro  
Branco/ouro



REF. F-1039 SL | Branco/Plata  
Branco/Prata











REF. F-1039 WH | Branco/Blanco  
Branco/Branco



REF. F-1039 BK | Branco/Negro  
Branco/Preto

## + INFO

-  Acrílico + Metal+Metacrilato+Policarbonato
-  1/2/4h
-  4 aspas retráctiles *palas retráteis*

|  | 1                  | 2                  | 3                  | 4                  | 5                  | 6                  | LED   |
|--|--------------------|--------------------|--------------------|--------------------|--------------------|--------------------|---|
| CONSUMO<br><i>Consumo</i>  | 6,2W               | 8,5W               | 10,8W              | 15,5W              | 20,8W              | 25,2W              |  72W                   |
| RPM<br><i>RPM</i>  | 175rpm             | 186rpm             | 202rpm             | 215rpm             | 225rpm             | 241rpm             |  6480lm                |
| FLUJO AIRE<br><i>Flujo de ar</i>   | 3754m <sup>3</sup> | 4803m <sup>3</sup> | 6336m <sup>3</sup> | 7665m <sup>3</sup> | 8848m <sup>3</sup> | 9953m <sup>3</sup> |  230 V ~ 50 Hz         |
| RUJIDO<br><i>Ruído</i>   | 26dB               | 29dB               | 32dB               | 35dB               | 39dB               | 41dB               |  3000K   4000K   6000K |

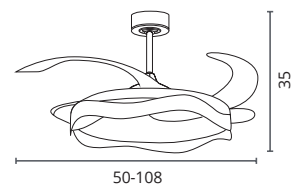





# Riga

retráctil



REF. F-1046 GL | Blanco/Oro  
Branco/Ouro



REF. F-1046 WH | Blanco/Blanco  
Branco/Branco



REF. F-1046 BK | Blanco/Negro  
Branco/Preto



REF. F-1046 SL | Blanco/Plata  
Branco/Prata

## + INFO

🔍 Acrílico + Metal+Metacrilato+Policarbonato

🕒 1/2/4h

🌀 4 aspas retráctiles *palas retráteis*

|                                  | 1                  | 2                  | 3                  | 4                  | 5                  | 6                  | LED                     |
|----------------------------------|--------------------|--------------------|--------------------|--------------------|--------------------|--------------------|-------------------------|
| CONSUMO<br><i>Consumo</i>        | 6,2W               | 8,5W               | 10,8W              | 15,5W              | 20,8W              | 25,2W              | 💡 72W                   |
| RPM<br><i>RPM</i>                | 175rpm             | 186rpm             | 202rpm             | 215rpm             | 225rpm             | 241rpm             | ⚙️ 6480lm               |
| FLUJO AIRE<br><i>Flujo de ar</i> | 3754m <sup>3</sup> | 4803m <sup>3</sup> | 6336m <sup>3</sup> | 7665m <sup>3</sup> | 8848m <sup>3</sup> | 9953m <sup>3</sup> | 🌀 230 V ~ 50 Hz         |
| RUJIDO<br><i>Ruído</i>           | 26dB               | 29dB               | 32dB               | 35dB               | 39dB               | 41dB               | 🌈 3000K   4000K   6000K |

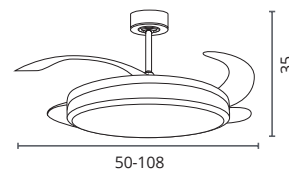







# Olas

retráctil



REF. F-1049 BK | Blanco/Negro  
Branco/Preto



REF. F-1049 WH | Blanco/Blanco  
Branco/Branco



REF. F-1049 SL | Blanco/Plata  
Branco/Prata



REF. F-1049 GL | Blanco/Oro  
Branco/Ouro



REF. F-1049 WO | Blanco/Haya  
Branco/Faixa

## + INFO

- Acrílico + Metal+Metacrilato+Policarbonato
- 1/2/4h
- 4 aspas retráctiles *palas retráteis*

|                                  | 1                  | 2                  | 3                  | 4                  | 5                  | 6                  | LED                   |
|----------------------------------|--------------------|--------------------|--------------------|--------------------|--------------------|--------------------|-----------------------|
| CONSUMO<br><i>Consumo</i>        | 6,2W               | 8,5W               | 10,8W              | 15,5W              | 20,8W              | 25,2W              | 72W                   |
| RPM<br><i>RPM</i>                | 175rpm             | 186rpm             | 202rpm             | 215rpm             | 225rpm             | 241rpm             | 6480lm                |
| FLUJO AIRE<br><i>Flujo de ar</i> | 3754m <sup>3</sup> | 4803m <sup>3</sup> | 6336m <sup>3</sup> | 7665m <sup>3</sup> | 8848m <sup>3</sup> | 9953m <sup>3</sup> | 230 V ~ 50 Hz         |
| RUJIDO<br><i>Ruído</i>           | 26dB               | 29dB               | 32dB               | 35dB               | 39dB               | 41dB               | 3000K   4000K   6000K |

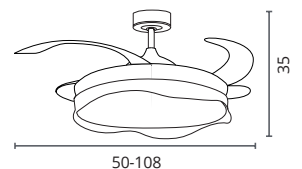







# Colors





retráctil



REF. F-1038 | Blanco Branco

## + INFO

-  Acrílico + Metal+Metacrilato+Policarbonato
-  1/2/4h
-  4 aspas retráctiles *palas retráteis*

|  | 1                  | 2                  | 3                  | 4                  | 5                  | 6                  | LED   |
|--|--------------------|--------------------|--------------------|--------------------|--------------------|--------------------|---|
| CONSUMO<br><i>Consumo</i>  | 6,2W               | 8,5W               | 10,8W              | 15,5W              | 20,8W              | 25,2W              |  72W                   |
| RPM<br><i>RPM</i>  | 175rpm             | 186rpm             | 202rpm             | 215rpm             | 225rpm             | 241rpm             |  6480lm                |
| FLUJO AIRE<br><i>Flujo de ar</i>   | 3754m <sup>3</sup> | 4803m <sup>3</sup> | 6336m <sup>3</sup> | 7665m <sup>3</sup> | 8848m <sup>3</sup> | 9953m <sup>3</sup> |  230 V ~ 50 Hz         |
| RUJIDO<br><i>Ruído</i>   | 26dB               | 29dB               | 32dB               | 35dB               | 39dB               | 41dB               |  3000K   4000K   6000K |

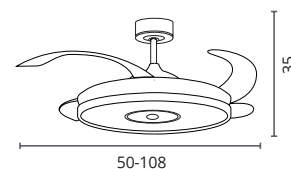





# Troya





retráctil



REF. V1008 | Blanco/Branco

## + INFO

-  Acrílico + Metal+Metacrilato+Policarbonato
-  1/2/4h
-  4 aspas retráctiles *palas retráteis*

|  | 1                  | 2                  | 3                  | 4                  | 5                  | 6                  | LED   |
|--|--------------------|--------------------|--------------------|--------------------|--------------------|--------------------|---|
| CONSUMO<br><i>Consumo</i>  | 6,2W               | 8,5W               | 10,8W              | 15,5W              | 20,8W              | 25,2W              |  72W                   |
| RPM<br><i>RPM</i>  | 175rpm             | 186rpm             | 202rpm             | 215rpm             | 225rpm             | 241rpm             |  6480lm                |
| FLUJO AIRE<br><i>Fluxo de ar</i>   | 3754m <sup>3</sup> | 4803m <sup>3</sup> | 6336m <sup>3</sup> | 7665m <sup>3</sup> | 8848m <sup>3</sup> | 9953m <sup>3</sup> |  230 V ~ 50 Hz         |
| RUJIDO<br><i>Ruído</i>   | 26dB               | 29dB               | 32dB               | 35dB               | 39dB               | 41dB               |  3000K   4000K   6000K |

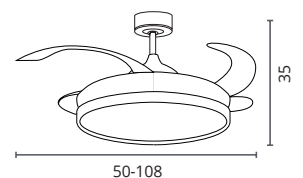





# Slim

retráctil



REF. F-1035 WO | Blanco/Haya  
Branco/Faia



REF. F-1035 BK | Blanco/Negro  
Branco/Preto



REF. F-1035 | Blanco Branco

## + INFO

🌀 Acrílico + Metal+Metacrilato+Policarbonato

🕒 1/2/4h

🌀 4 aspas retráctiles *palas retráteis*

|                                  | 1                  | 2                  | 3                  | 4                  | 5                  | 6                  | LED                     |
|----------------------------------|--------------------|--------------------|--------------------|--------------------|--------------------|--------------------|-------------------------|
| CONSUMO<br><i>Consumo</i>        | 6,2W               | 8,5W               | 10,8W              | 15,5W              | 20,8W              | 25,2W              | 💡 72W                   |
| RPM<br><i>RPM</i>                | 175rpm             | 186rpm             | 202rpm             | 215rpm             | 225rpm             | 241rpm             | ⚙️ 6480lm               |
| FLUJO AIRE<br><i>Flujo de ar</i> | 3754m <sup>3</sup> | 4803m <sup>3</sup> | 6336m <sup>3</sup> | 7665m <sup>3</sup> | 8848m <sup>3</sup> | 9953m <sup>3</sup> | 🌀 230 V ~ 50 Hz         |
| RUJIDO<br><i>Ruído</i>           | 26dB               | 29dB               | 32dB               | 35dB               | 39dB               | 41dB               | 🌈 3000K   4000K   6000K |

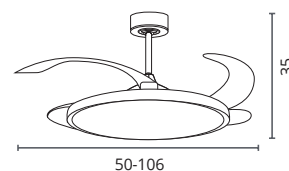







# Antea

retráctil



REF. F-1027 | Blanco Branco

**i** Combinación de color de la luz  
Combinção de cores da luz

## + INFO

- Acrílico + Metal+Metacrilato+Policarbonato
- 2/4h
- 4 aspas retráctiles *palas retráteis*

|                                  | 1                  | 2                  | 3                  | 4                  | 5                  | 6                  | LED                   |
|----------------------------------|--------------------|--------------------|--------------------|--------------------|--------------------|--------------------|-----------------------|
| CONSUMO<br><i>Consumo</i>        | 6,2W               | 8,5W               | 10,8W              | 15,5W              | 20,8W              | 25,2W              | 72W                   |
| RPM<br><i>RPM</i>                | 175rpm             | 186rpm             | 202rpm             | 215rpm             | 225rpm             | 241rpm             | 6480lm                |
| FLUJO AIRE<br><i>Fluxo de ar</i> | 3754m <sup>3</sup> | 4803m <sup>3</sup> | 6336m <sup>3</sup> | 7665m <sup>3</sup> | 8848m <sup>3</sup> | 9953m <sup>3</sup> | 230 V ~ 50 Hz         |
| RUJIDO<br><i>Ruído</i>           | 26dB               | 29dB               | 32dB               | 35dB               | 39dB               | 41dB               | 3000K   4000K   6000K |

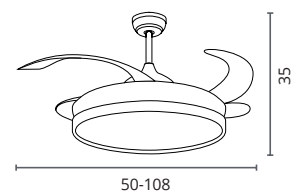







# Atlas

retráctil



REF. F-1026 | Blanco Branco

**i** **Combinación de color de la luz**  
*Combinação de cores da luz*

**+ INFO**

- Acrílico + Metal+Metacrilato+Policarbonato
- 2/4h
- 4 aspas retráctiles *palas retráteis*

|                                  | 1                  | 2                  | 3                  | 4                  | 5                  | 6                  | LED                   |
|----------------------------------|--------------------|--------------------|--------------------|--------------------|--------------------|--------------------|-----------------------|
| CONSUMO<br><i>Consumo</i>        | 6,2W               | 8,5W               | 10,8W              | 15,5W              | 20,8W              | 25,2W              | 72W                   |
| RPM<br><i>RPM</i>                | 175rpm             | 186rpm             | 202rpm             | 215rpm             | 225rpm             | 241rpm             | 6480lm                |
| FLUJO AIRE<br><i>Fluxo de ar</i> | 3754m <sup>3</sup> | 4803m <sup>3</sup> | 6336m <sup>3</sup> | 7665m <sup>3</sup> | 8848m <sup>3</sup> | 9953m <sup>3</sup> | 230 V ~ 50 Hz         |
| RUJIDO<br><i>Ruído</i>           | 26dB               | 29dB               | 32dB               | 35dB               | 39dB               | 41dB               | 3000K   4000K   6000K |

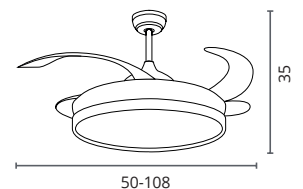



REF. F-3002 BR | Blanco/Marrón *Branco/Castanho*

## Mini



REF. F-3002 GL | Blanco/Oro  
*Branco/Ouro*



REF. F-3002 BK | Blanco/Negro  
*Branco/Preto*



REF. F-3002 SL | Blanco/Plata  
*Branco/Prata*



REF. F-3002 WH | Blanco/Blanco  
*Branco/ Branco*

### + INFO

- ⊕ Acrílico + Metal+Metacrilato+Policarbonato
- ⌚ 1/2/4h
- ⚙️ 4 aspas retráctiles *palas retráteis*

|                                  | 1                  | 2                  | 3                  | 4                  | 5                  | 6                  | LED                     |
|----------------------------------|--------------------|--------------------|--------------------|--------------------|--------------------|--------------------|-------------------------|
| CONSUMO<br><i>Consumo</i>        | 5,7W               | 6,7W               | 9,6W               | 12,4W              | 15,2W              | 21,6W              | ⚡ 48W                   |
| RPM                              | 172rpm             | 187rpm             | 202rpm             | 217rpm             | 232rpm             | 262rpm             | ☀️ 4800lm               |
| FLUJO AIRE<br><i>Flujo de ar</i> | 2100m <sup>3</sup> | 2600m <sup>3</sup> | 3500m <sup>3</sup> | 4900m <sup>3</sup> | 6100m <sup>3</sup> | 7000m <sup>3</sup> | ⚡ 230 V ~ 50 Hz         |
| RUIDO<br><i>Ruído</i>            | 26dB               | 27dB               | 30dB               | 33dB               | 36dB               | 41dB               | 🌈 3000K   4000K   6000K |

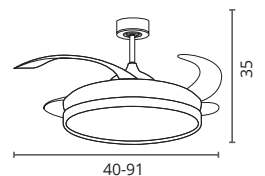

# Kigali

retráctil



REF. F-3001 BK | Blanco/Negro  
Branco/Preto



REF. F-3001 GL | Blanco/Oro  
Branco/Ouro



REF. F-3001 BR | Blanco/Marrón  
Branco/Castanho



REF. F-3001 SL | Blanco/Plata  
Branco/Prata



REF. F-3001 WH | Blanco/Blanco  
Branco/ Branco

## + INFO

Acrílico + Metal+Metacrilato+Policarbonato

1/2/4h

4 aspas retráctiles *palas retráteis*

|                                  | 1                  | 2                  | 3                  | 4                  | 5                  | 6                  | LED                   |
|----------------------------------|--------------------|--------------------|--------------------|--------------------|--------------------|--------------------|-----------------------|
| CONSUMO<br><i>Consumo</i>        | 6,2W               | 8,5W               | 10,8W              | 15,5W              | 20,8W              | 25,2W              | 72W                   |
| RPM<br><i>RPM</i>                | 175rpm             | 186rpm             | 202rpm             | 215rpm             | 225rpm             | 241rpm             | 6480lm                |
| FLUJO AIRE<br><i>Flujo de ar</i> | 3754m <sup>3</sup> | 4803m <sup>3</sup> | 6336m <sup>3</sup> | 7665m <sup>3</sup> | 8848m <sup>3</sup> | 9953m <sup>3</sup> | 230 V ~ 50 Hz         |
| RUJIDO<br><i>Ruído</i>           | 26dB               | 29dB               | 32dB               | 35dB               | 39dB               | 41dB               | 3000K   4000K   6000K |

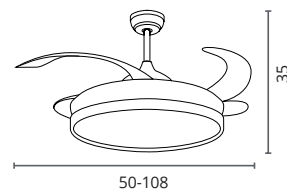





# Kigali

plafón



REF. B-3002 BK | REF. B-3001 BK  
Blanco/ Negro Branco/Preto



REF. B-3001 GL | REF. B-3002 GL  
Blanco/Oro Branco/Ouro



REF. B-3001 BR | REF. B-3002 BR  
Blanco/ Marrón Branco/Castanho



REF. B-3001 SL | REF. B-3002 SL  
Blanco/ Plata Branco/Prata



REF. B-3001 WH | REF. B-3002 WH  
Blanco/ Blanco Branco/Branco

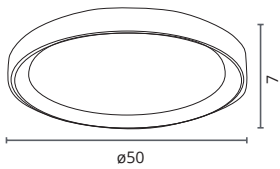

**i** Ø50: REF 01

LED + INFO

- 72W
  - 6480lm
  - 230 V ~ 50 Hz
  - 3000K | 4000K | 6000K
- Acrílico +Policarbonato

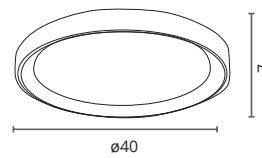

**i** Ø40: REF 02

LED + INFO

- 48W
  - 4800lm
  - 230 V ~ 50 Hz
  - 3000K | 4000K | 6000K
- Acrílico +Policarbonato







# Dafne

retráctil



REF. F-1015 | Blanco *Branco*



REF. F-1017 | Negro *Preto*

**i** **Combinación de color de la luz**  
*Combinação de cores da luz*

**+ INFO**

- Acrílico + Metal+Metacrilato+Policarbonato
- 1/2/4h
- 4 aspas retráctiles *palas retráteis*

|                                  | 1                  | 2                  | 3                  | 4                  | 5                  | 6                  | LED                   |
|----------------------------------|--------------------|--------------------|--------------------|--------------------|--------------------|--------------------|-----------------------|
| CONSUMO<br><i>Consumo</i>        | 6,2W               | 8,5W               | 10,8W              | 15,5W              | 20,8W              | 25,2W              | 72W                   |
| RPM<br><i>RPM</i>                | 175rpm             | 186rpm             | 202rpm             | 215rpm             | 225rpm             | 241rpm             | 6480lm                |
| FLUJO AIRE<br><i>Fluxo de ar</i> | 3754m <sup>3</sup> | 4803m <sup>3</sup> | 6336m <sup>3</sup> | 7665m <sup>3</sup> | 8848m <sup>3</sup> | 9953m <sup>3</sup> | 230 V ~ 50 Hz         |
| RUJIDO<br><i>Ruído</i>           | 26dB               | 29dB               | 32dB               | 35dB               | 39dB               | 41dB               | 3000K   4000K   6000K |

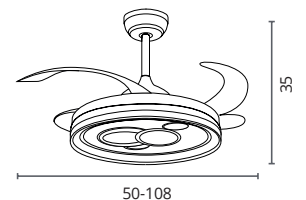







# Amaltea

retráctil+plafón



Solo plafón  
Só plafond



REF. F-1032 | Blanco Branco



REF. B-1032 | Blanco Branco

**i** **Combinación de color de la luz**  
Combinção de cores da luz

**+ INFO**

- Acrílico + Metal+Metacrilato+Policarbonato
- 1/2/4h
- 4 aspas retráctiles *palas retráteis*

|                                  | 1                  | 2                  | 3                  | 4                  | 5                  | 6                  | LED                   |
|----------------------------------|--------------------|--------------------|--------------------|--------------------|--------------------|--------------------|-----------------------|
| CONSUMO<br><i>Consumo</i>        | 6,2W               | 8,5W               | 10,8W              | 15,5W              | 20,8W              | 25,2W              | 116W                  |
| RPM<br><i>RPM</i>                | 175rpm             | 186rpm             | 202rpm             | 215rpm             | 225rpm             | 241rpm             | 10900lm               |
| FLUJO AIRE<br><i>Fluxo de ar</i> | 3754m <sup>3</sup> | 4803m <sup>3</sup> | 6336m <sup>3</sup> | 7665m <sup>3</sup> | 8848m <sup>3</sup> | 9953m <sup>3</sup> | 230 V ~ 50 Hz         |
| RUJIDO<br><i>Ruído</i>           | 26dB               | 29dB               | 32dB               | 35dB               | 39dB               | 41dB               | 3000K   4000K   6500K |

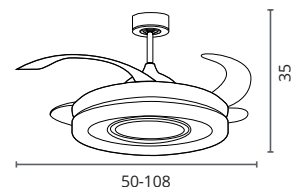
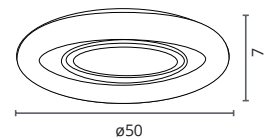





# Hersa

retráctil



Solo plafón  
Só plafond



REF. F-1033 | Blanco Branco

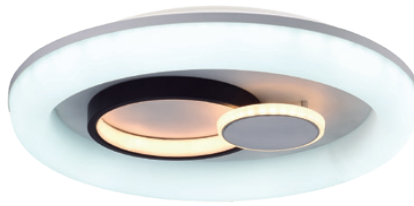

REF. B-1033 | Blanco Branco

**i** Combinación de color de la luz  
Combinação de cores da luz

## + INFO

- Acrílico + Metal+Metacrilato+Policarbonato
- 1/2/4h
- 4 aspas retráctiles *palas retráteis*

|                                  | 1                  | 2                  | 3                  | 4                  | 5                  | 6                  | LED                   |
|----------------------------------|--------------------|--------------------|--------------------|--------------------|--------------------|--------------------|-----------------------|
| CONSUMO<br><i>Consumo</i>        | 6,2W               | 8,5W               | 10,8W              | 15,5W              | 20,8W              | 25,2W              | 116W                  |
| RPM<br><i>RPM</i>                | 175rpm             | 186rpm             | 202rpm             | 215rpm             | 225rpm             | 241rpm             | 10900lm               |
| FLUJO AIRE<br><i>Fluxo de ar</i> | 3754m <sup>3</sup> | 4803m <sup>3</sup> | 6336m <sup>3</sup> | 7665m <sup>3</sup> | 8848m <sup>3</sup> | 9953m <sup>3</sup> | 230 V ~ 50 Hz         |
| RUJIDO<br><i>Ruído</i>           | 26dB               | 29dB               | 32dB               | 35dB               | 39dB               | 41dB               | 3000K   4000K   6500K |

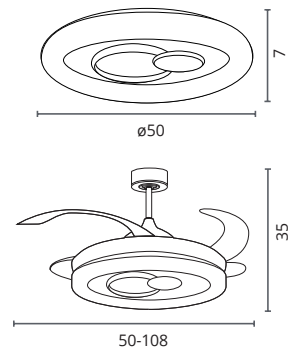





# Hermes

retráctil



Solo plafón  
Só plafond



REF. F-1030 | Blanco Branco

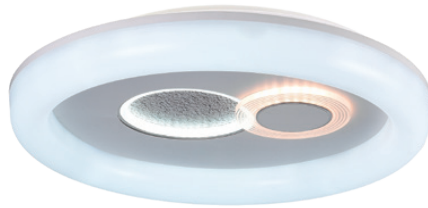

REF. B-1030 | Blanco Branco

**i** Combinación de color de la luz  
Combinção de cores da luz

+ INFO

- Acrílico + Metal+Metacrilato+Policarbonato
- 1/2/4h
- 4 aspas retráctiles *palas retráteis*

|                                  | 1                  | 2                  | 3                  | 4                  | 5                  | 6                  | LED                   |
|----------------------------------|--------------------|--------------------|--------------------|--------------------|--------------------|--------------------|-----------------------|
| CONSUMO<br><i>Consumo</i>        | 6,2W               | 8,5W               | 10,8W              | 15,5W              | 20,8W              | 25,2W              | 108W                  |
| RPM<br><i>RPM</i>                | 175rpm             | 186rpm             | 202rpm             | 215rpm             | 225rpm             | 241rpm             | 10200lm               |
| FLUJO AIRE<br><i>Flujo de ar</i> | 3754m <sup>3</sup> | 4803m <sup>3</sup> | 6336m <sup>3</sup> | 7665m <sup>3</sup> | 8848m <sup>3</sup> | 9953m <sup>3</sup> | 230 V ~ 50 Hz         |
| RUJIDO<br><i>Ruído</i>           | 26dB               | 29dB               | 32dB               | 35dB               | 39dB               | 41dB               | 3000K   4000K   6500K |

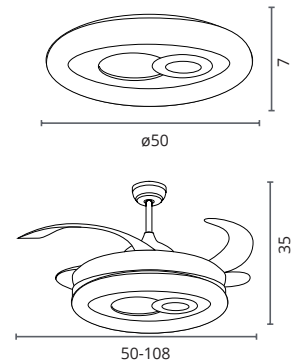





# Tebe

retráctil



Solo plafón  
Só plafond



REF. F-1031 | Blanco Branco



REF. B-1031 | Blanco Branco

**i** Combinación de color de la luz  
Combinção de cores da luz

## + INFO

- Acrílico + Metal+Metacrilato+Policarbonato
- 1/2/4h
- 4 aspas retráctiles *palas retráteis*

|                                  | 1                  | 2                  | 3                  | 4                  | 5                  | 6                  | LED                   |
|----------------------------------|--------------------|--------------------|--------------------|--------------------|--------------------|--------------------|-----------------------|
| CONSUMO<br><i>Consumo</i>        | 6,2W               | 8,5W               | 10,8W              | 15,5W              | 20,8W              | 25,2W              | 130W                  |
| RPM<br><i>RPM</i>                | 175rpm             | 186rpm             | 202rpm             | 215rpm             | 225rpm             | 241rpm             | 12300lm               |
| FLUJO AIRE<br><i>Fluxo de ar</i> | 3754m <sup>3</sup> | 4803m <sup>3</sup> | 6336m <sup>3</sup> | 7665m <sup>3</sup> | 8848m <sup>3</sup> | 9953m <sup>3</sup> | 230 V ~ 50 Hz         |
| RUJIDO<br><i>Ruído</i>           | 26dB               | 29dB               | 32dB               | 35dB               | 39dB               | 41dB               | 3000K   4000K   6000K |

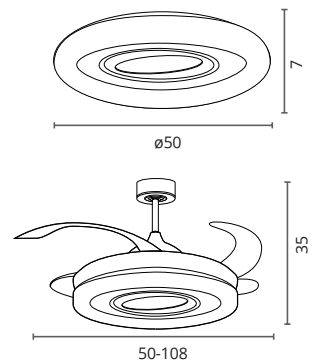







# Acanto

retráctil



REF. F-1029 SL | Plata *Prata*



REF. F-1029 GL | Oro *Ouro*

## + INFO

- ◊ Acrílico + Metal+Metacrilato+Policarbonato
- 🕒 2/4h
- 🌀 4 aspas retráctiles *palas retráteis*

|                                  | 1                  | 2                  | 3                  | 4                  | 5                  | 6                  | LED                     |
|----------------------------------|--------------------|--------------------|--------------------|--------------------|--------------------|--------------------|-------------------------|
| CONSUMO<br><i>Consumo</i>        | 6,2W               | 8,5W               | 10,8W              | 15,5W              | 20,8W              | 25,2W              | 💡 72W                   |
| RPM<br><i>RPM</i>                | 175rpm             | 186rpm             | 202rpm             | 215rpm             | 225rpm             | 241rpm             | ⚙️ 7200lm               |
| FLUJO AIRE<br><i>Flujo de ar</i> | 3754m <sup>3</sup> | 4803m <sup>3</sup> | 6336m <sup>3</sup> | 7665m <sup>3</sup> | 8848m <sup>3</sup> | 9953m <sup>3</sup> | 🌀 230 V ~ 50 Hz         |
| RUJIDO<br><i>Ruído</i>           | 26dB               | 29dB               | 32dB               | 35dB               | 39dB               | 41dB               | 🌈 3000K   4000K   6000K |

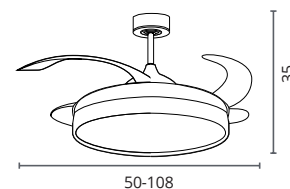



# Trio

retráctil



REF. B-28500WH | Blanco Branco

**i** **Combinación de color de la luz**  
*Combinação de cores da luz*

**+ INFO**

- Acrílico + Metal+Metacrilato+Policarbonato
- 1/2/4h
- 4 aspas retráctiles *palas retráteis*

|                                  | 1                  | 2                  | 3                  | 4                  | 5                  | 6                  | LED                   |
|----------------------------------|--------------------|--------------------|--------------------|--------------------|--------------------|--------------------|-----------------------|
| CONSUMO<br><i>Consumo</i>        | 6,2W               | 8,5W               | 10,8W              | 15,5W              | 20,8W              | 25,2W              | 72W                   |
| RPM<br><i>RPM</i>                | 175rpm             | 186rpm             | 202rpm             | 215rpm             | 225rpm             | 241rpm             | 6480lm                |
| FLUJO AIRE<br><i>Fluxo de ar</i> | 3754m <sup>3</sup> | 4803m <sup>3</sup> | 6336m <sup>3</sup> | 7665m <sup>3</sup> | 8848m <sup>3</sup> | 9953m <sup>3</sup> | 230 V ~ 50 Hz         |
| RUJIDO<br><i>Ruído</i>           | 26dB               | 29dB               | 32dB               | 35dB               | 39dB               | 41dB               | 3000K   4000K   6000K |

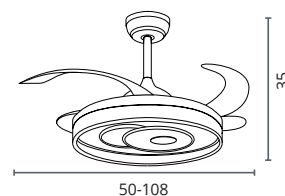





# Toronto

retráctil



REF. F-1036 | Blanco Branco

Compatible con:  
Compatível com:



## + INFO

- Acrílico + Metal+Metacrilato+Policarbonato
- 1/2/4h
- 4 aspas retráctiles *palas retráteis*

|                                  | 1                  | 2                  | 3                  | 4                  | 5                  | 6                  | LED                   |
|----------------------------------|--------------------|--------------------|--------------------|--------------------|--------------------|--------------------|-----------------------|
| CONSUMO<br><i>Consumo</i>        | 6,2W               | 8,5W               | 10,8W              | 15,5W              | 20,8W              | 25,2W              | 72W                   |
| RPM<br><i>RPM</i>                | 175rpm             | 186rpm             | 202rpm             | 215rpm             | 225rpm             | 241rpm             | 6480lm                |
| FLUJO AIRE<br><i>Fluxo de ar</i> | 3754m <sup>3</sup> | 4803m <sup>3</sup> | 6336m <sup>3</sup> | 7665m <sup>3</sup> | 8848m <sup>3</sup> | 9953m <sup>3</sup> | 230 V ~ 50 Hz         |
| RUJIDO<br><i>Ruído</i>           | 26dB               | 29dB               | 32dB               | 35dB               | 39dB               | 41dB               | 3000K   4000K   6000K |

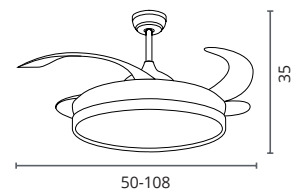







# Quebec

retráctil



REF. F-1037 | Blanco Branco

Compatible con:  
Compatível com:



+ INFO

- Acrílico + Metal+Metacrilato+Policarbonato
- 1/2/4h
- 4 aspas retráctiles *palas retráteis*

|                                  | 1                  | 2                  | 3                  | 4                  | 5                  | 6                  | LED                   |
|----------------------------------|--------------------|--------------------|--------------------|--------------------|--------------------|--------------------|-----------------------|
| CONSUMO<br><i>Consumo</i>        | 6,2W               | 8,5W               | 10,8W              | 15,5W              | 20,8W              | 25,2W              | 72W                   |
| RPM<br><i>RPM</i>                | 175rpm             | 186rpm             | 202rpm             | 215rpm             | 225rpm             | 241rpm             | 6480lm                |
| FLUJO AIRE<br><i>Flujo de ar</i> | 3754m <sup>3</sup> | 4803m <sup>3</sup> | 6336m <sup>3</sup> | 7665m <sup>3</sup> | 8848m <sup>3</sup> | 9953m <sup>3</sup> | 230 V ~ 50 Hz         |
| RUJIDO<br><i>Ruído</i>           | 26dB               | 29dB               | 32dB               | 35dB               | 39dB               | 41dB               | 3000K   4000K   6000K |

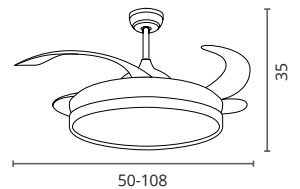



# Arcos

retráctil



REF. F-1010 | Blanco Branco

Compatible con:  
Compatível com:



## + INFO

- Acrílico + Metal+Metacrilato+Policarbonato
- 1/2/4h
- 4 aspas retráctiles *palas retráteis*

|                                  | 1                  | 2                  | 3                  | 4                  | 5                  | 6                  | LED                   |
|----------------------------------|--------------------|--------------------|--------------------|--------------------|--------------------|--------------------|-----------------------|
| CONSUMO<br><i>Consumo</i>        | 6,2W               | 8,5W               | 10,8W              | 15,5W              | 20,8W              | 25,2W              | 72W                   |
| RPM<br><i>RPM</i>                | 175rpm             | 186rpm             | 202rpm             | 215rpm             | 225rpm             | 241rpm             | 6480lm                |
| FLUJO AIRE<br><i>Flujo de ar</i> | 3754m <sup>3</sup> | 4803m <sup>3</sup> | 6336m <sup>3</sup> | 7665m <sup>3</sup> | 8848m <sup>3</sup> | 9953m <sup>3</sup> | 230 V ~ 50 Hz         |
| RUJIDO<br><i>Ruído</i>           | 26dB               | 29dB               | 32dB               | 35dB               | 39dB               | 41dB               | 3000K   4000K   6000K |

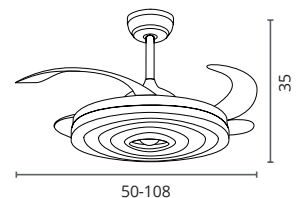





# Sfera

retráctil



REF. B-28500WH | Blanco *Branco*



REF. B-28500BK | Negro *Preto*



REF. B-28500SL | Plata *Prata*



REF. B-28500GL | Dorado *Dourado*

## + INFO

- Acrílico + Metal+Metacrilato+Policarbonato
- 1/2/4h
- 4 aspas retráctiles *palas retráteis*

|                                  | 1                  | 2                  | 3                  | 4                  | 5                  | 6                  | LED                   |
|----------------------------------|--------------------|--------------------|--------------------|--------------------|--------------------|--------------------|-----------------------|
| CONSUMO<br><i>Consumo</i>        | 6,2W               | 8,5W               | 10,8W              | 15,5W              | 20,8W              | 25,2W              | 72W                   |
| RPM<br><i>RPM</i>                | 175rpm             | 186rpm             | 202rpm             | 215rpm             | 225rpm             | 241rpm             | 6480lm                |
| FLUJO AIRE<br><i>Flujo de ar</i> | 3754m <sup>3</sup> | 4803m <sup>3</sup> | 6336m <sup>3</sup> | 7665m <sup>3</sup> | 8848m <sup>3</sup> | 9953m <sup>3</sup> | 230 V ~ 50 Hz         |
| RUJIDO<br><i>Ruído</i>           | 26dB               | 29dB               | 32dB               | 35dB               | 39dB               | 41dB               | 3000K   4000K   6000K |

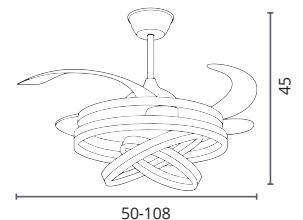







# Kepler

retráctil



REF. F-1028 SL | Plata Prata



REF. F-1028 GL | Oro Ouro

## + INFO

- Acrílico + Metal+Metacrilato+Policarbonato
- 1/2/4h
- 4 aspas retráctiles *palas retráteis*

|                                  | 1                  | 2                  | 3                  | 4                  | 5                  | 6                  | LED                   |
|----------------------------------|--------------------|--------------------|--------------------|--------------------|--------------------|--------------------|-----------------------|
| CONSUMO<br><i>Consumo</i>        | 6,2W               | 8,5W               | 10,8W              | 15,5W              | 20,8W              | 25,2W              | 72W                   |
| RPM<br><i>RPM</i>                | 175rpm             | 186rpm             | 202rpm             | 215rpm             | 225rpm             | 241rpm             | 7200lm                |
| FLUJO AIRE<br><i>Fluxo de ar</i> | 3754m <sup>3</sup> | 4803m <sup>3</sup> | 6336m <sup>3</sup> | 7665m <sup>3</sup> | 8848m <sup>3</sup> | 9953m <sup>3</sup> | 230 V ~ 50 Hz         |
| RUJIDO<br><i>Ruído</i>           | 26dB               | 29dB               | 32dB               | 35dB               | 39dB               | 41dB               | 3000K   4000K   6000K |

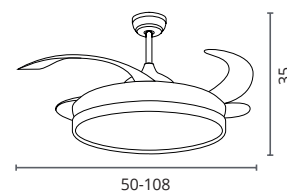





# Asgard Maxi

retráctil



REF. F2005 | Blanco Branco



REF. F2006 | Negro Preto

**i** MAXI de aspas 120 cm  
MAXI de palas 120 cm

**+ INFO**

- Acrílico + Metal+Metacrilato+Policarbonato
- 2/4h
- 4 aspas retráctiles *palas retráteis*

|                                  | 1                  | 2                  | 3                  | 4                  | 5                  | 6                   | LED                   |
|----------------------------------|--------------------|--------------------|--------------------|--------------------|--------------------|---------------------|-----------------------|
| CONSUMO<br><i>Consumo</i>        | 8W                 | 10,5W              | 14,4W              | 19,5W              | 25,6W              | 32W                 | 72W                   |
| RPM<br><i>RPM</i>                | 100rpm             | 114rpm             | 130rpm             | 143rpm             | 159rpm             | 175rpm              | 6480lm                |
| FLUJO AIRE<br><i>Fluxo de ar</i> | 3612m <sup>3</sup> | 4843m <sup>3</sup> | 6639m <sup>3</sup> | 8101m <sup>3</sup> | 9512m <sup>3</sup> | 10948m <sup>3</sup> | 230 V ~ 50 Hz         |
| RUJIDO<br><i>Ruído</i>           | 40dB               | 40,3dB             | 41dB               | 42dB               | 42,5dB             | 43,5dB              | 3000K   4000K   6000K |

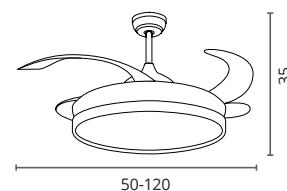





## Mini



REF. F1006-40 | Negro *Preto*



REF. F1005-40 | Blanco *Branco*

### + INFO

- ◈ Acrílico + Metal+Metacrilato+Policarbonato
- 🕒 2/4h
- 🌀 4 aspas retráctiles *palas retráteis*

|            | 1                  | 2                  | 3                  | 4                  | 5                  | 6                  | LED                     |
|------------|--------------------|--------------------|--------------------|--------------------|--------------------|--------------------|-------------------------|
| CONSUMO    | 5,7W               | 6,7W               | 9,6W               | 12,4W              | 15,2W              | 21,6W              | 💡 48W                   |
| RPM        | 172rpm             | 187rpm             | 202rpm             | 217rpm             | 232rpm             | 262rpm             | ⚡ 4800lm                |
| FLUJO AIRE | 2100m <sup>3</sup> | 2600m <sup>3</sup> | 3500m <sup>3</sup> | 4900m <sup>3</sup> | 6100m <sup>3</sup> | 7000m <sup>3</sup> | 🌀 230 V ~ 50 Hz         |
| RUIDO      | 26dB               | 27dB               | 30dB               | 33dB               | 36dB               | 41dB               | 🌈 3000K   4000K   6000K |

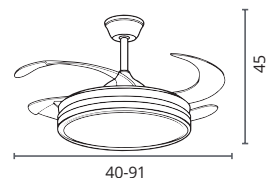

# Asgard



REF. F1018 | Níquel *Níquel*



REF. F1006 | Negro *Preto*



REF. F1005 | Blanco *Branco*



REF. F1019 | Cuero *Oxidado*

## + INFO

- Acrílico + Metal+Metacrilato+Policarbonato
- 2/4h
- 4 aspas retráctiles *palas retráteis*

|                                  | 1                  | 2                  | 3                  | 4                  | 5                  | 6                  | LED                   |
|----------------------------------|--------------------|--------------------|--------------------|--------------------|--------------------|--------------------|-----------------------|
| CONSUMO<br><i>Consumo</i>        | 6,2W               | 8,5W               | 10,8W              | 15,5W              | 20,8W              | 25,2W              | 72W                   |
| RPM<br><i>RPM</i>                | 175rpm             | 186rpm             | 202rpm             | 215rpm             | 225rpm             | 241rpm             | 6480lm                |
| FLUJO AIRE<br><i>Flujo de ar</i> | 3754m <sup>3</sup> | 4803m <sup>3</sup> | 6336m <sup>3</sup> | 7665m <sup>3</sup> | 8848m <sup>3</sup> | 9953m <sup>3</sup> | 230 V ~ 50 Hz         |
| RUJIDO<br><i>Ruído</i>           | 26dB               | 29dB               | 32dB               | 35dB               | 39dB               | 41dB               | 3000K   4000K   6000K |

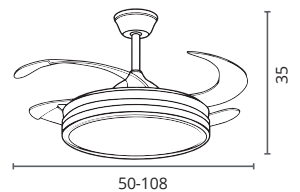





## Mini



REF. B-28400-40 WO  
Blanco/Haya Branco/Faia



REF. B-28400-40 BK  
Negro/Haya Preto/Faia

### + INFO

- 🔍 Acrílico + Metal+Metacrilato+Policarbonato
- 🕒 1/2/4h
- 🌀 4 aspas retráctiles *palas retráteis*

|            | 1                  | 2                  | 3                  | 4                  | 5                  | 6                  | LED                     |
|------------|--------------------|--------------------|--------------------|--------------------|--------------------|--------------------|-------------------------|
| CONSUMO    | 5,7W               | 6,7W               | 9,6W               | 12,4W              | 15,2W              | 21,6W              | 💡 48W                   |
| RPM        | 172rpm             | 187rpm             | 202rpm             | 217rpm             | 232rpm             | 262rpm             | 🌀 4800lm                |
| FLUJO AIRE | 2100m <sup>3</sup> | 2600m <sup>3</sup> | 3500m <sup>3</sup> | 4900m <sup>3</sup> | 6100m <sup>3</sup> | 7000m <sup>3</sup> | 🌀 230 V ~ 50 Hz         |
| RUIDO      | 26dB               | 27dB               | 30dB               | 33dB               | 36dB               | 41dB               | 🌈 3000K   4000K   6000K |

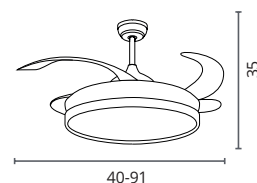



# Cosmos

retráctil



REF. B-28400BK | Negro/Haya  
Preto/Faia



REF. B-28400WO | Blanco/Haya  
Branco/Faia

## + INFO

- Acrílico + Metal+Metacrilato+Policarbonato
- 1/2/4h
- 4 aspas retráctiles *palas retráteis*

|                                  | 1                  | 2                  | 3                  | 4                  | 5                  | 6                  | LED                   |
|----------------------------------|--------------------|--------------------|--------------------|--------------------|--------------------|--------------------|-----------------------|
| CONSUMO<br><i>Consumo</i>        | 6,2W               | 8,5W               | 10,8W              | 15,5W              | 20,8W              | 25,2W              | 72W                   |
| RPM<br><i>RPM</i>                | 175rpm             | 186rpm             | 202rpm             | 215rpm             | 225rpm             | 241rpm             | 6480lm                |
| FLUJO AIRE<br><i>Fluxo de ar</i> | 3754m <sup>3</sup> | 4803m <sup>3</sup> | 6336m <sup>3</sup> | 7665m <sup>3</sup> | 8848m <sup>3</sup> | 9953m <sup>3</sup> | 230 V ~ 50 Hz         |
| RUJIDO<br><i>Ruído</i>           | 26dB               | 29dB               | 32dB               | 35dB               | 39dB               | 41dB               | 3000K   4000K   6000K |

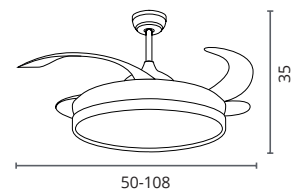



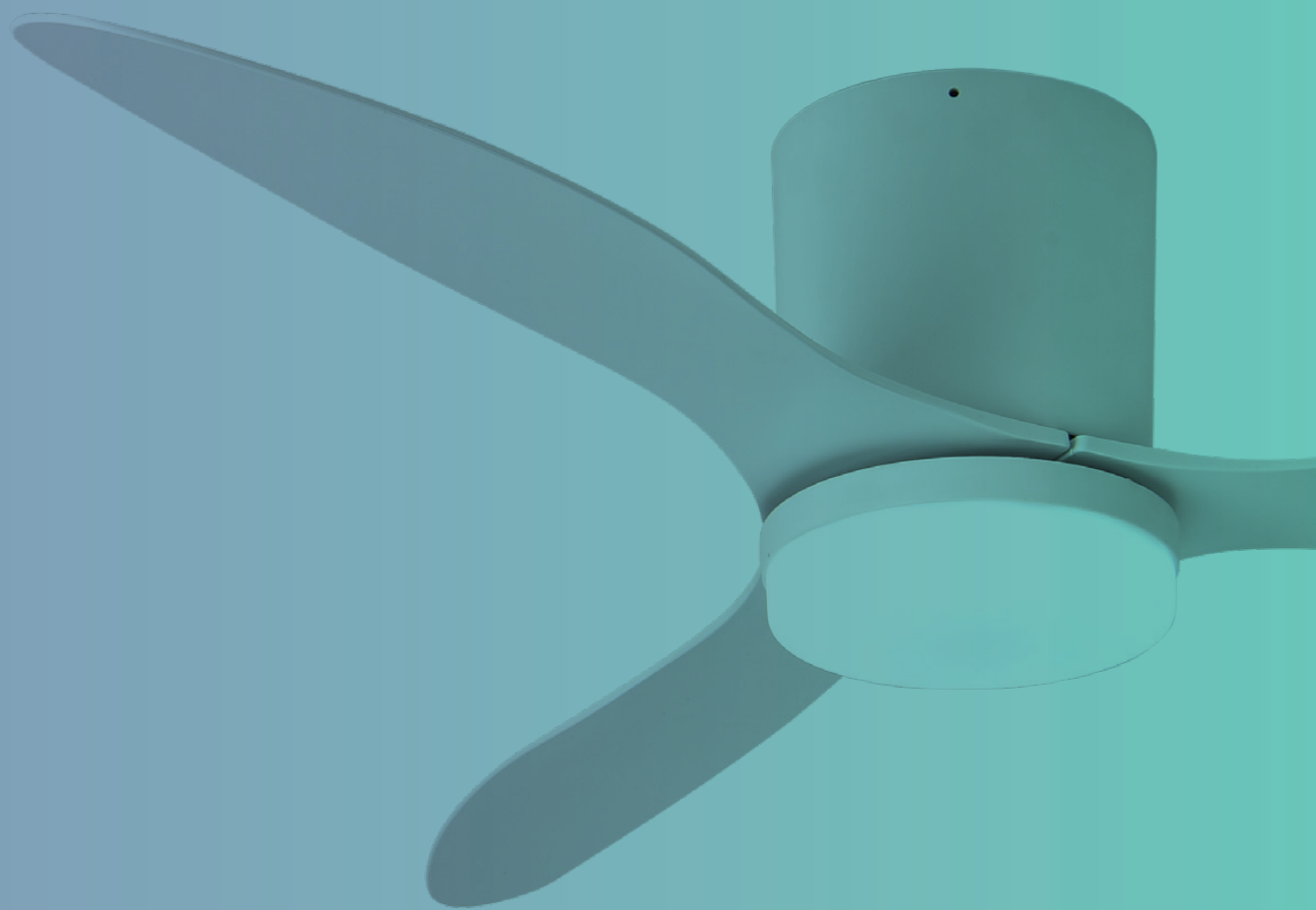

# Ventiladores aspas

*Ventoinhas com pásas fixas*

**2**





# Alison

aspas



REF. F-1060 | Blanco *Branco*



**i** Este ventilador está catalogado con un tamaño S aunque sus dimensiones son iguales o mayores que un ventilador retráctil.

*Esta ventoinha está categorizada como tamanho S, embora as suas dimensões sejam iguais ou superiores às de uma ventoinha retrátil.*

## + INFO

Acrílico + Metal+Policarbonato

1/2/4h

3 aspas *palas*

|                                  | 1                  | 2                  | 3                  | 4                  | 5                  | 6                  | LED                   |
|----------------------------------|--------------------|--------------------|--------------------|--------------------|--------------------|--------------------|-----------------------|
| CONSUMO<br><i>Consumo</i>        | 3,4W               | 8W                 | 11W                | 18W                | 24,5W              | 30W                | 250W                  |
| RPM<br><i>RPM</i>                | 180rpm             | 220rpm             | 260rpm             | 290rpm             | 330rpm             | 380rpm             | 2200lm                |
| FLUJO AIRE<br><i>Flujo de ar</i> | 2150m <sup>3</sup> | 2400m <sup>3</sup> | 2900m <sup>3</sup> | 3300m <sup>3</sup> | 3800m <sup>3</sup> | 4100m <sup>3</sup> | 230 V ~ 50 Hz         |
| RUIDO<br><i>Ruido</i>            | 25dB               | 29dB               | 33dB               | 37dB               | 42dB               | 45dB               | 3000K   4000K   6000K |

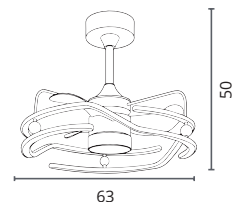







# Trébol

aspas



REF. F-1061 | Blanco Branco

**i** Este ventilador está catalogado con un tamaño S aunque sus dimensiones son iguales o mayores que un ventilador retráctil.

*Esta ventoinha está categorizada como tamanho S, embora as suas dimensões sejam iguais ou superiores às de uma ventoinha retrátil.*

## + INFO

Acrílico + Metal+Policarbonato

1/2/4h

3 aspas *palas*

|                                  | 1                  | 2                  | 3                  | 4                  | 5                  | 6                  | LED                   |
|----------------------------------|--------------------|--------------------|--------------------|--------------------|--------------------|--------------------|-----------------------|
| CONSUMO<br><i>Consumo</i>        | 3,4W               | 8W                 | 11W                | 18W                | 24,5W              | 30W                | 200W                  |
| RPM<br><i>RPM</i>                | 180rpm             | 220rpm             | 260rpm             | 290rpm             | 330rpm             | 380rpm             | 1900lm                |
| FLUJO AIRE<br><i>Flujo de ar</i> | 2150m <sup>3</sup> | 2400m <sup>3</sup> | 2900m <sup>3</sup> | 3300m <sup>3</sup> | 3800m <sup>3</sup> | 4100m <sup>3</sup> | 230 V ~ 50 Hz         |
| RUJIDO<br><i>Ruído</i>           | 25dB               | 29dB               | 33dB               | 37dB               | 42dB               | 45dB               | 3000K   4000K   6000K |

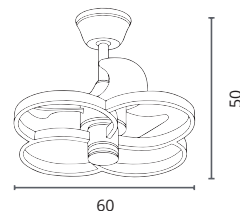



# Enebro

aspas



REF. F-1063 WH | Blanco *Branco*



REF. F-1063 BK | Negro *Preto*

**i** Este ventilador está catalogado con un tamaño S aunque sus dimensiones son iguales o mayores que un ventilador retráctil.  
*Esta ventoinha está categorizada como tamanho S, embora as suas dimensões sejam iguais ou superiores às de uma ventoinha retrátil.*

## + INFO

- Acrílico + Metal+Policarbonato
- 1/2/4h
- 3 aspas *palas*

|                                  | 1                  | 2                  | 3                  | 4                  | 5                  | 6                  | LED                   |
|----------------------------------|--------------------|--------------------|--------------------|--------------------|--------------------|--------------------|-----------------------|
| CONSUMO<br><i>Consumo</i>        | 3,4W               | 8W                 | 11W                | 18W                | 24,5W              | 30W                | 60W                   |
| RPM<br><i>RPM</i>                | 180rpm             | 220rpm             | 260rpm             | 290rpm             | 330rpm             | 380rpm             | 500lm                 |
| FLUJO AIRE<br><i>Fluxo de ar</i> | 2150m <sup>3</sup> | 2400m <sup>3</sup> | 2900m <sup>3</sup> | 3300m <sup>3</sup> | 3800m <sup>3</sup> | 4100m <sup>3</sup> | 230 V ~ 50 Hz         |
| RUJIDO<br><i>Ruído</i>           | 25dB               | 29dB               | 33dB               | 37dB               | 42dB               | 45dB               | 3000K   4000K   6000K |

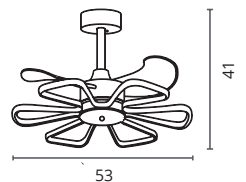





# Karla

aspas



REF. F-1062 | Blanco *Branco*

**i** Este ventilador está catalogado con un tamaño S aunque sus dimensiones son iguales o mayores que un ventilador retráctil.

*Esta ventoinha está categorizada como tamanho S, embora as suas dimensões sejam iguais ou superiores às de uma ventoinha retrátil.*

## + INFO

Acrílico + Metal+Policarbonato

1/2/4h

3 aspas *palas*

|                                  | 1                  | 2                  | 3                  | 4                  | 5                  | 6                  | LED                   |
|----------------------------------|--------------------|--------------------|--------------------|--------------------|--------------------|--------------------|-----------------------|
| CONSUMO<br><i>Consumo</i>        | 3,4W               | 8W                 | 11W                | 18W                | 24,5W              | 30W                | 130W                  |
| RPM<br><i>RPM</i>                | 180rpm             | 220rpm             | 260rpm             | 290rpm             | 330rpm             | 380rpm             | 1100lm                |
| FLUJO AIRE<br><i>Flujo de ar</i> | 2150m <sup>3</sup> | 2400m <sup>3</sup> | 2900m <sup>3</sup> | 3300m <sup>3</sup> | 3800m <sup>3</sup> | 4100m <sup>3</sup> | 230 V ~ 50 Hz         |
| RUIDO<br><i>Ruído</i>            | 25dB               | 29dB               | 33dB               | 37dB               | 42dB               | 45dB               | 3000K   4000K   6000K |

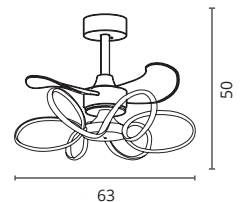







# Imbat

aspas



REF. 202296302 | Marrón *Castanho*



**i** Este ventilador está catalogado con un tamaño S aunque sus dimensiones son iguales o mayores que un ventilador retráctil.  
*Esta ventoinha está categorizada como tamanho S, embora as suas dimensões sejam iguais ou superiores às de uma ventoinha retrátil.*

## + INFO

# LUMIT®

- Aluminio + Metal+ABS
- 1/2/4h
- 3 aspas *palas*

|                                  | 1                  | 2                  | 3                  | 4                  | 5                  | 6                  | LED                   |
|----------------------------------|--------------------|--------------------|--------------------|--------------------|--------------------|--------------------|-----------------------|
| CONSUMO<br><i>Consumo</i>        | 5,4W               | 7,9W               | 11,3W              | 18,5W              | 23,2W              | 27,9W              | 152W                  |
| RPM<br><i>RPM</i>                | 191rpm             | 227rpm             | 267rpm             | 301rpm             | 342rpm             | 376rpm             | 3500lm                |
| FLUJO AIRE<br><i>Flujo de ar</i> | 2150m <sup>3</sup> | 2450m <sup>3</sup> | 2870m <sup>3</sup> | 3190m <sup>3</sup> | 3560m <sup>3</sup> | 3850m <sup>3</sup> | 230 V ~ 50 Hz         |
| RUJIDO<br><i>Ruido</i>           | 22dB               | 25dB               | 29dB               | 32dB               | 38dB               | 45dB               | 3000K   4000K   6500K |

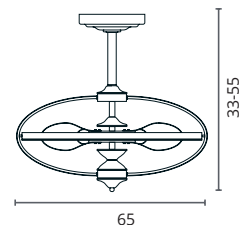





# Kai

aspas



REF. 202396001 | Blanco Branco



**i** Este ventilador está catalogado con un tamaño S aunque sus dimensiones son iguales o mayores que un ventilador retráctil.

*Esta ventoinha está categorizada como tamanho S, embora as suas dimensões sejam iguais ou superiores às de uma ventoinha retrátil.*

## + INFO

# LUMIT®

Aluminio + Metal+ABS

1/2/4h

3 aspas *palas*

|                                  | 1                  | 2                  | 3                  | 4                  | 5                  | 6                  | LED                   |
|----------------------------------|--------------------|--------------------|--------------------|--------------------|--------------------|--------------------|-----------------------|
| CONSUMO<br><i>Consumo</i>        | 5,4W               | 7,9W               | 11,3W              | 18,5W              | 23,2W              | 27,9W              | 120W                  |
| RPM<br><i>RPM</i>                | 191rpm             | 227rpm             | 267rpm             | 301rpm             | 342rpm             | 376rpm             | 2500lm                |
| FLUJO AIRE<br><i>Flujo de ar</i> | 2150m <sup>3</sup> | 2450m <sup>3</sup> | 2870m <sup>3</sup> | 3190m <sup>3</sup> | 3560m <sup>3</sup> | 3850m <sup>3</sup> | 230 V ~ 50 Hz         |
| RUJIDO<br><i>Ruído</i>           | 22dB               | 25dB               | 29dB               | 32dB               | 38dB               | 45dB               | 3000K   4000K   6500K |

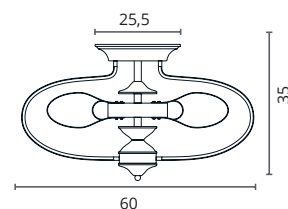





## Mini



REF. B-2540 | Blanco *Branco*









REF. B-2541 | Blanco/Haya  
*Branco/Faixa*



REF. B-2542 | Negro/Cerezo  
*Preto/Cerejeira*

### + INFO

-  ABS + Policarbonato
-  2/4h
-  3 *aspas palas*

|                                  | 1                  | 2                  | 3                  | 4                  | 5                  | 6                  | LED  |
|----------------------------------|--------------------|--------------------|--------------------|--------------------|--------------------|--------------------|--|
| CONSUMO<br><i>Consumo</i>        | 2,75W              | 3,75W              | 5,3W               | 7,3W               | 10,6W              | 15,5W              |  48W                   |
| RPM<br><i>RPM</i>                | 93rpm              | 110rpm             | 128rpm             | 146rpm             | 175rpm             | 205rpm             |  4800lm                |
| FLUJO AIRE<br><i>Flujo de ar</i> | 1625m <sup>3</sup> | 1922m <sup>3</sup> | 2265m <sup>3</sup> | 2650m <sup>3</sup> | 4015m <sup>3</sup> | 4200m <sup>3</sup> |  230 V ~ 50 Hz         |
| RUIDO<br><i>Ruido</i>            | 3dB                | 4,6dB              | 5,7dB              | 7,2dB              | 19,8dB             | 24,5dB             |  3000K   4000K   6000K |

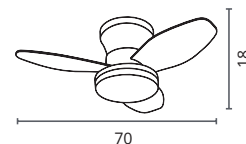

# Tauro

aspas



REF. B-2543 | Blanco *Branco*



REF. B-2544 | Blanco/Haya  
*Branco/Faixa*



REF. B-2545 | Negro/Cerezo  
*Preto/Cerejeira*

## + INFO

- ABS+Policarbonato
- 2/4h
- 3 aspas *palas*

|                                  | 1                  | 2                  | 3                  | 4                  | 5                  | 6                  | LED                   |
|----------------------------------|--------------------|--------------------|--------------------|--------------------|--------------------|--------------------|-----------------------|
| CONSUMO<br><i>Consumo</i>        | 2,75W              | 3,75W              | 5,3W               | 7,3W               | 10,6W              | 15,5W              | 48W                   |
| RPM<br><i>RPM</i>                | 93rpm              | 110rpm             | 128rpm             | 146rpm             | 175rpm             | 205rpm             | 4800lm                |
| FLUJO AIRE<br><i>Flujo de ar</i> | 1625m <sup>3</sup> | 1922m <sup>3</sup> | 2265m <sup>3</sup> | 2650m <sup>3</sup> | 4015m <sup>3</sup> | 4200m <sup>3</sup> | 230 V ~ 50 Hz         |
| RUJIDO<br><i>Ruido</i>           | 3dB                | 4,6dB              | 5,7dB              | 7,2dB              | 19,8dB             | 24,5dB             | 3000K   4000K   6000K |

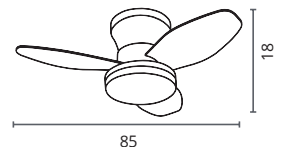







# Mistral

aspas



REF. B-2547 | Blanco/Haya  
Branco/Faixa



REF. B-2546 | Blanco Branco



REF. B-2548 | Negro/Cerezo  
Preto/Cerejeira

## + INFO

- Metal +ABS + Policarbonato
- 1/2/4h
- 3 aspas *palas*

|                                  | 1                  | 2                  | 3                  | 4                  | 5                  | 6                  | LED                   |
|----------------------------------|--------------------|--------------------|--------------------|--------------------|--------------------|--------------------|-----------------------|
| CONSUMO<br><i>Consumo</i>        | 8W                 | 10,5W              | 14,5W              | 19,5W              | 25,5W              | 32W                | 48W                   |
| RPM<br><i>RPM</i>                | 100rpm             | 114rpm             | 130rpm             | 143rpm             | 159rpm             | 175rpm             | 4800lm                |
| FLUJO AIRE<br><i>Flujo de ar</i> | 3284m <sup>3</sup> | 4403m <sup>3</sup> | 6036m <sup>3</sup> | 7365m <sup>3</sup> | 8648m <sup>3</sup> | 9953m <sup>3</sup> | 230 V ~ 50 Hz         |
| RUJIDO<br><i>Ruido</i>           | 40dB               | 40,3dB             | 41dB               | 42dB               | 42,5dB             | 43,5dB             | 3000K   4000K   6500K |

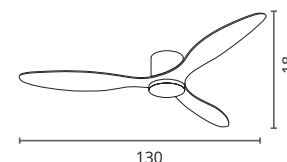





# Siroco on

aspas



REF. V1021 BK/WO | Negro/Haya  
Preto /Faia



REF. V1021 WH/WO | Blanco/Haya  
Branco/Faia



REF. V1021 WH/OAK | Blanco/Roble  
Branco/Carvalho



REF. V1021 BK/OAK | Negro/Roble  
Preto/Carvalho

## + INFO

- ⊗ Metal + ABS + Policarbonato
- 🕒 1/2/4h
- 🌀 3 aspas *palas*

|                                  | 1                  | 2                  | 3                  | 4                  | 5                  | 6                  | LED                     |
|----------------------------------|--------------------|--------------------|--------------------|--------------------|--------------------|--------------------|-------------------------|
| CONSUMO<br><i>Consumo</i>        | 8W                 | 10,5W              | 14,5W              | 19,5W              | 25,5W              | 32W                | 💡 40W                   |
| RPM<br><i>RPM</i>                | 100rpm             | 114rpm             | 130rpm             | 143rpm             | 159rpm             | 175rpm             | ⚡ 4000lm                |
| FLUJO AIRE<br><i>Flujo de ar</i> | 3284m <sup>3</sup> | 4403m <sup>3</sup> | 6036m <sup>3</sup> | 7365m <sup>3</sup> | 8648m <sup>3</sup> | 9953m <sup>3</sup> | 🌀 230 V ~ 50 Hz         |
| RUJIDO<br><i>Ruido</i>           | 40dB               | 40.3dB             | 41dB               | 42dB               | 42,5dB             | 43,5dB             | 🌈 3000K   4000K   6500K |

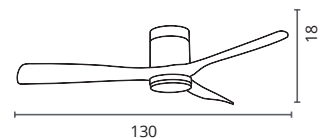





# Siroco off

aspas



REF. V1020 BK/WO | Negro/Haya  
Preto /Faia



REF. V1020 WH/WO | Blanco/Haya  
Branco/Faia

## + INFO

- Metal + ABS
- 1/2/4h
- 3 aspas *palas*

|                                  | 1                  | 2                  | 3                  | 4                  | 5                  | 6                  |
|----------------------------------|--------------------|--------------------|--------------------|--------------------|--------------------|--------------------|
| CONSUMO<br><i>Consumo</i>        | 8W                 | 10,5W              | 14,5W              | 19,5W              | 25,5W              | 32W                |
| RPM<br><i>RPM</i>                | 100rpm             | 114rpm             | 130rpm             | 143rpm             | 159rpm             | 175rpm             |
| FLUJO AIRE<br><i>Flujo de ar</i> | 3284m <sup>3</sup> | 4403m <sup>3</sup> | 6036m <sup>3</sup> | 7365m <sup>3</sup> | 8648m <sup>3</sup> | 9953m <sup>3</sup> |
| RUJIDO<br><i>Ruido</i>           | 40dB               | 40.3dB             | 41dB               | 42dB               | 42,5dB             | 43,5dB             |

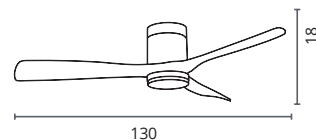







# Orion

aspas



REF. F-1040 BK | Negro *Preto*



REF. F-1040 WH | Blanco *Branco*

## + INFO

- Acrílico + Metal+Metacrilato+Policarbonato
- 1/2/4h
- 6 aspas *palas*

|                                  | 1                  | 2                  | 3                  | 4                  | 5                  | 6                  | LED                   |
|----------------------------------|--------------------|--------------------|--------------------|--------------------|--------------------|--------------------|-----------------------|
| CONSUMO<br><i>Consumo</i>        | 15W                | 20W                | 24.6W              | 29,5W              | 35W                | 43W                | 72W                   |
| RPM<br><i>RPM</i>                | 153rpm             | 168rpm             | 180rpm             | 193rpm             | 205rpm             | 215rpm             | 6480lm                |
| FLUJO AIRE<br><i>Flujo de ar</i> | 5445m <sup>3</sup> | 6309m <sup>3</sup> | 7393m <sup>3</sup> | 7645m <sup>3</sup> | 8009m <sup>3</sup> | 8393m <sup>3</sup> | 230 V ~ 50 Hz         |
| RUJIDO<br><i>Ruido</i>           | 28dB               | 31dB               | 34dB               | 38dB               | 41dB               | 45dB               | 3000K   4000K   6000K |

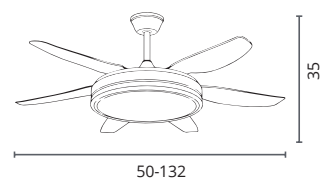





# Tulum

aspas



REF. B-2651WH | Blanco *Branco*



REF. B-2653SN | NíquelHaya  
*Níquel Faia*



REF. B-2652BR | Marrón *Castanho*

## + INFO

- 🔍 Cristal + Metal + ABS *vidro*
- 🕒 1/2/4h
- 🌀 3 aspas *palas*

|                                  | 1                  | 2                  | 3                  | 4                  | 5                  | 6                  | LED                     |
|----------------------------------|--------------------|--------------------|--------------------|--------------------|--------------------|--------------------|-------------------------|
| CONSUMO<br><i>Consumo</i>        | 8W                 | 10,5W              | 14,4W              | 19,5W              | 25,6W              | 32W                | 💡 25W                   |
| RPM<br><i>RPM</i>                | 100rpm             | 114rpm             | 130rpm             | 143rpm             | 159rpm             | 175rpm             | 🌀 2500lm                |
| FLUJO AIRE<br><i>Flujo de ar</i> | 3284m <sup>3</sup> | 4403m <sup>3</sup> | 6036m <sup>3</sup> | 7365m <sup>3</sup> | 8648m <sup>3</sup> | 9953m <sup>3</sup> | 🌀 230 V ~ 50 Hz         |
| RUJIDO<br><i>Ruído</i>           | 40dB               | 40,3dB             | 41dB               | 42dB               | 42,5dB             | 45,3dB             | 🌈 3000K   4000K   6000K |

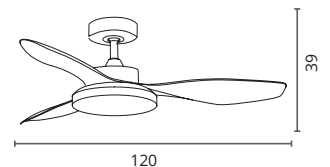







# Nasim

aspas



REF. 200295210B | Plata Prata



+ INFO

**LUMIT®**

- Cristal + Metal+ABS Vidro
- 2/4/8h
- 3 aspas palas

|                                  | 1                  | 2                  | 3                  | 4                  | 5                  | 6                  | LED           |
|----------------------------------|--------------------|--------------------|--------------------|--------------------|--------------------|--------------------|---------------|
| CONSUMO<br><i>Consumo</i>        | 2,5W               | 3W                 | 6W                 | 11W                | 18W                | 29W                | 16W           |
| RPM<br><i>RPM</i>                | 50rpm              | 80rpm              | 110rpm             | 140rpm             | 170rpm             | 200rpm             | 1600lm        |
| FLUJO AIRE<br><i>Flujo de ar</i> | 5540m <sup>3</sup> | 5980m <sup>3</sup> | 6530m <sup>3</sup> | 6842m <sup>3</sup> | 7230m <sup>3</sup> | 7615m <sup>3</sup> | 230 V ~ 50 Hz |
| RUIDO<br><i>Ruido</i>            | 30dB               | 31dB               | 32dB               | 36dB               | 42dB               | 47dB               | 4000K         |

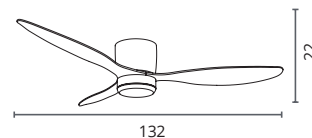





# Delfos

aspas



REF. B-2751 WH | Blanco *Branco*



REF. B-2753 AB | Cuero (AB)/Cereza  
*Oxidado (AB)/Cerejeira*



REF. B-2752 SN | Níquel/Haya  
*Níquel/Faia*

## + INFO

*Shakespeare*  
Fantastic Design | Since 1949

- Metal + ABS
- 1/2/4h
- 3 aspas *palas*

|                                  | 1                  | 2                  | 3                  | 4                  | 5                  | 6                  | LED           |
|----------------------------------|--------------------|--------------------|--------------------|--------------------|--------------------|--------------------|---------------|
| CONSUMO<br><i>Consumo</i>        | 8W                 | 10,5W              | 14,4W              | 19,5W              | 25,6W              | 32W                | 20W           |
| RPM<br><i>RPM</i>                | 100rpm             | 114rpm             | 130rpm             | 143rpm             | 159rpm             | 175rpm             | 2000lm        |
| FLUJO AIRE<br><i>Flujo de ar</i> | 3284m <sup>3</sup> | 4403m <sup>3</sup> | 6036m <sup>3</sup> | 7365m <sup>3</sup> | 8648m <sup>3</sup> | 9953m <sup>3</sup> | 230 V ~ 50 Hz |
| RUJIDO<br><i>Ruido</i>           | 40dB               | 40,3dB             | 41dB               | 42dB               | 42,5dB             | 45,3dB             | 4000K         |

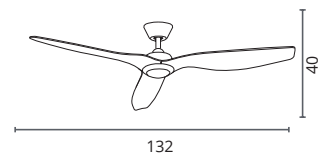





# Bravo



aspas







REF. 200795202B | Níquel/Madera  
Níquel /Madeira

+ INFO

**LUMIT®**

-  Cristal + Metal + ABS *vidro*
-  2/4/8h
-  3 aspas *palas*

|                                  | 1                  | 2                  | 3                  | 4                  | 5                  | 6                  | LED   |
|----------------------------------|--------------------|--------------------|--------------------|--------------------|--------------------|--------------------|---|
| CONSUMO<br><i>Consumo</i>        | 3,5W               | 5,5W               | 8,5W               | 12,5W              | 18,5W              | 27W                |  16W           |
| RPM<br><i>RPM</i>                | 100rpm             | 120rpm             | 140rpm             | 160rpm             | 180rpm             | 200rpm             |  1600lm        |
| FLUJO AIRE<br><i>Flujo de ar</i> | 5440m <sup>3</sup> | 5880m <sup>3</sup> | 6330m <sup>3</sup> | 6642m <sup>3</sup> | 7130m <sup>3</sup> | 7415m <sup>3</sup> |  230 V ~ 50 Hz |
| RUJIDO<br><i>Ruído</i>           | 33dB               | 34dB               | 35dB               | 37dB               | 40dB               | 43dB               |  4000K         |

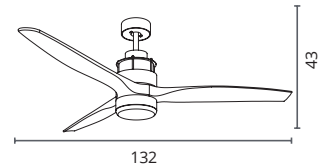





# Marino

aspas



REF. 200594802B | Marrón *Castanho*



REF. 200594810B | Plata *Prata*



REF. 200594801B | Blanco *Branco*

+ INFO

**LUMIT®**

🔍 Cristal + Metal+ABS *Vidro*

🕒 2/4/8h

🌀 3 aspas *palas*

|                                  | 1                  | 2                  | 3                  | 4                  | 5                  | 6                  | LED             |
|----------------------------------|--------------------|--------------------|--------------------|--------------------|--------------------|--------------------|-----------------|
| CONSUMO<br><i>Consumo</i>        | 2,5W               | 3,5W               | 5W                 | 7W                 | 10,5W              | 14W                | 💡 16W           |
| RPM<br><i>RPM</i>                | 100rpm             | 120rpm             | 140rpm             | 160rpm             | 180rpm             | 200rpm             | ⚡ 1600lm        |
| FLUJO AIRE<br><i>Flujo de ar</i> | 5540m <sup>3</sup> | 5880m <sup>3</sup> | 6330m <sup>3</sup> | 6642m <sup>3</sup> | 6930m <sup>3</sup> | 7127m <sup>3</sup> | 🌀 230 V ~ 50 Hz |
| RUJIDO<br><i>Ruido</i>           | 34dB               | 35dB               | 36dB               | 37dB               | 38dB               | 39dB               | ● 4000K         |

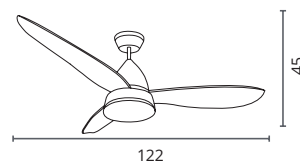





# Poniente

aspas



REF. 200394603B | Níquel *Níquel*

+ INFO

**LUMIT®**

- Cristal + Metal+ABS *Vidro*
- 2/4/8h
- 3 aspas *palas*

|                                  | 1                  | 2                  | 3                  | 4                  | 5                  | 6                  | LED           |
|----------------------------------|--------------------|--------------------|--------------------|--------------------|--------------------|--------------------|---------------|
| CONSUMO<br><i>Consumo</i>        | 4W                 | 4,5W               | 9,5W               | 13,5W              | 20W                | 30W                | 16W           |
| RPM<br><i>RPM</i>                | 100rpm             | 120rpm             | 140rpm             | 160rpm             | 180rpm             | 200rpm             | 1600lm        |
| FLUJO AIRE<br><i>Flujo de ar</i> | 3540m <sup>3</sup> | 3980m <sup>3</sup> | 4530m <sup>3</sup> | 4842m <sup>3</sup> | 5230m <sup>3</sup> | 5615m <sup>3</sup> | 230 V ~ 50 Hz |
| RUJIDO<br><i>Ruido</i>           | 33dB               | 35dB               | 37dB               | 38dB               | 42dB               | 44dB               | 4000K         |

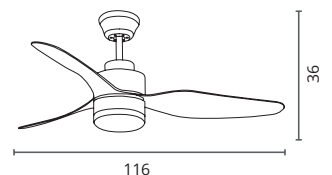





# Kilim

aspas

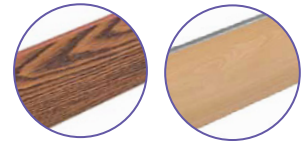

3 Aspas reversibles  
3 Palas reversíveis

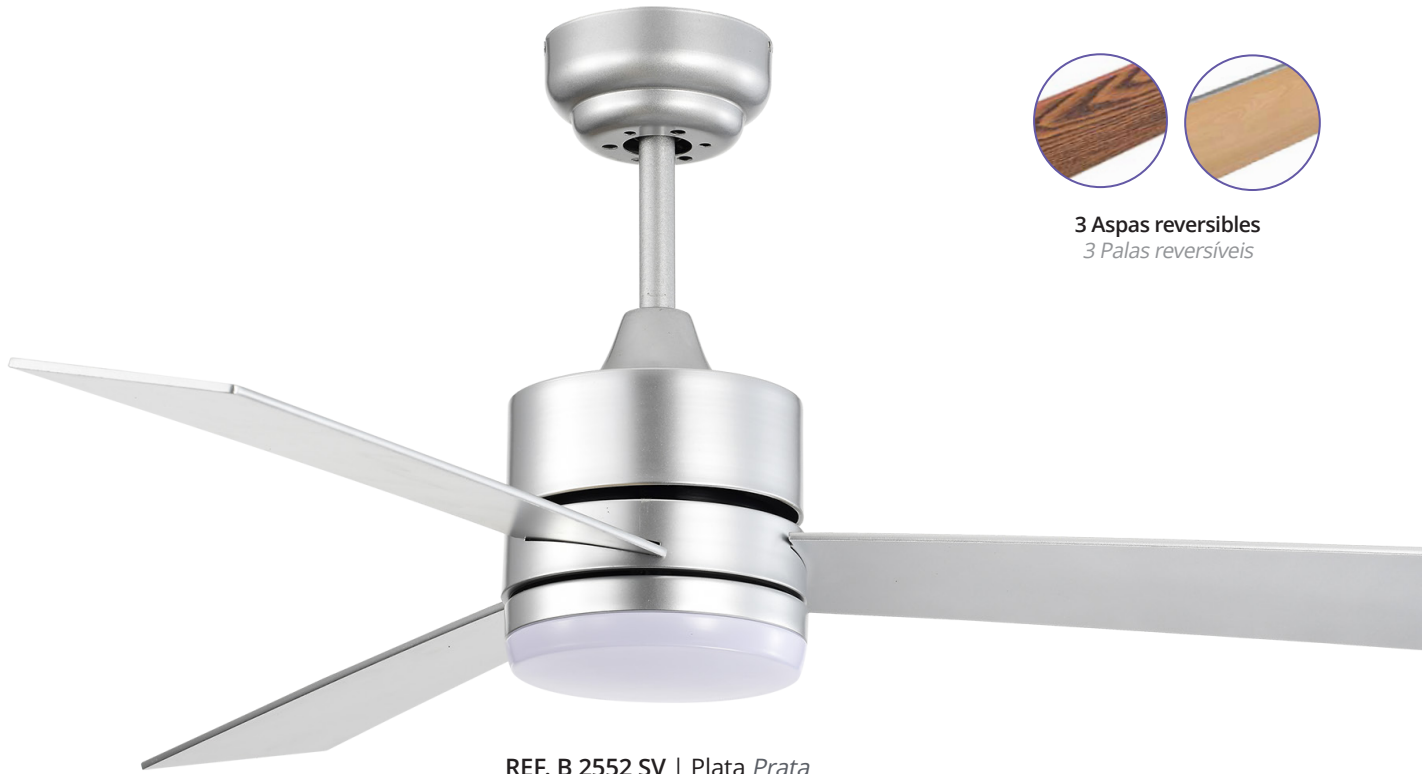

REF. B 2552 SV | Plata Prata  
Plata/Haya Prata/Faia



REF. B 2553 SN | Níquel Níquel  
Cerezo/Nogal Cerejeira/Nogueira



REF. B 2551 WH | Blanco Branco  
Blanco/Haya Branco/Faia

## + INFO

*Shakespeare*  
Fantastic Design | Since 1949

- Madera + Acrílico + Metal *Madeira*
- 1/2/4h
- 3 aspas *palas*

|                                  | 1                  | 2                  | 3                  | 4                  | 5                  | 6                  | LED                   |
|----------------------------------|--------------------|--------------------|--------------------|--------------------|--------------------|--------------------|-----------------------|
| CONSUMO<br><i>Consumo</i>        | 2,75W              | 3,75W              | 5,3W               | 7,3W               | 10,6W              | 15,5W              | 18W                   |
| RPM<br><i>RPM</i>                | 93rpm              | 110rpm             | 128rpm             | 146rpm             | 175rpm             | 205rpm             | 1800lm                |
| FLUJO AIRE<br><i>Flujo de ar</i> | 1625m <sup>3</sup> | 1922m <sup>3</sup> | 2265m <sup>3</sup> | 2650m <sup>3</sup> | 4015m <sup>3</sup> | 4200m <sup>3</sup> | 230 V ~ 50 Hz         |
| RUIDO<br><i>Ruído</i>            | 3dB                | 4,6dB              | 5,7dB              | 7,2dB              | 28,5dB             | 35dB               | 3000K   4000K   6500K |

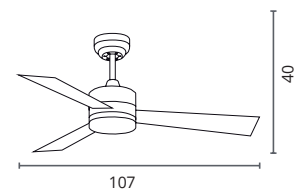





# Kenia

aspas

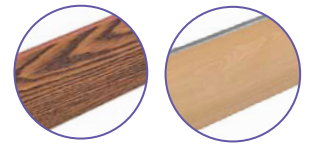

3 Aspas reversibles  
3 Palas reversíveis



REF. B 2555 SV | Plata Prata  
Plata/Haya Prata/Faia



REF. B 2556 AB | Cuero (AB) Oxidado (AB)  
Cerezo/Nogal Cerejeira/Nogueira



REF. B 2554 WH | Blanco Branco  
Blanco/Haya Branco/Faia

## + INFO

*Shakespeare*  
Fantastic Design Since 1949

🌀 Madera + Acrílico + Metal *Madeira*

🕒 1/2/4h

🌀 4 aspas *palas*

|                                  | 1                  | 2                  | 3                  | 4                  | 5                  | 6                  | LED                     |
|----------------------------------|--------------------|--------------------|--------------------|--------------------|--------------------|--------------------|-------------------------|
| CONSUMO<br><i>Consumo</i>        | 2,75W              | 3,75W              | 5,3W               | 7,3W               | 10,6W              | 15,5W              | 💡 18W                   |
| RPM<br><i>RPM</i>                | 93rpm              | 110rpm             | 128rpm             | 146rpm             | 175rpm             | 205rpm             | ⚙️ 1800lm               |
| FLUJO AIRE<br><i>Flujo de ar</i> | 1625m <sup>3</sup> | 1922m <sup>3</sup> | 2265m <sup>3</sup> | 2650m <sup>3</sup> | 4015m <sup>3</sup> | 4200m <sup>3</sup> | 🌀 230 V ~ 50 Hz         |
| RUJIDO<br><i>Ruido</i>           | 3dB                | 4,6dB              | 5,7dB              | 7,2dB              | 28,5dB             | 35dB               | 🌈 3000K   4000K   6500K |

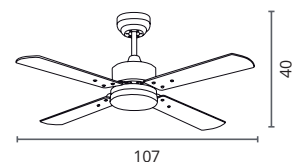





# Cathay



plafón







REF. B28170WO | Blanco/Madera  
Branco/Madeira

**i** **Rejilla giratoria**  
Grelha rotativa

+ INFO

-  Acrílico + Metal
-  2h
-  5 aspas *palas*

|                                  | 1                  | 2                  | 3                  | 4                  | LED   |
|----------------------------------|--------------------|--------------------|--------------------|--------------------|---|
| CONSUMO<br><i>Consumo</i>        | 6,2W               | 8,5W               | 10,8W              | 20,8W              |  72W           |
| RPM<br><i>RPM</i>                | 175rpm             | 186rpm             | 202rpm             | 225rpm             |  6800lm        |
| FLUJO AIRE<br><i>Flujo de ar</i> | 3754m <sup>3</sup> | 4803m <sup>3</sup> | 6336m <sup>3</sup> | 8848m <sup>3</sup> |  230 V ~ 50 Hz |
| RUJIDO<br><i>Ruido</i>           | 26dB               | 29dB               | 32dB               | 39dB               |  3000K - 6000K |

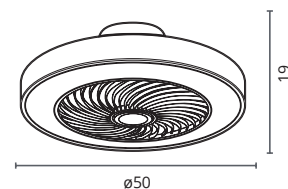





# Raki Move

plafón









REF. B-28210 | Blanco *Branco*

**i** Flujo de aire bidireccional  
Fluxo de ar bidireccional



+ INFO

-  Policarbonato+ABS
-  1/2/4h
-  7 aspas *palas*

|                                  | 1                  | 2                  | 3                  | 4                  | 5                  | 6                  | LED   |
|----------------------------------|--------------------|--------------------|--------------------|--------------------|--------------------|--------------------|---|
| CONSUMO<br><i>Consumo</i>        | 4W                 | 5W                 | 6W                 | 8W                 | 10W                | 12W                |  38W                   |
| RPM<br><i>RPM</i>                | 590rpm             | 720rpm             | 830rpm             | 940rpm             | 1040rpm            | 1140rpm            |  3800lm                |
| FLUJO AIRE<br><i>Flujo de ar</i> | 1980m <sup>3</sup> | 3000m <sup>3</sup> | 4500m <sup>3</sup> | 6000m <sup>3</sup> | 7500m <sup>3</sup> | 9000m <sup>3</sup> |  230 V ~ 50 Hz         |
| RUJIDO<br><i>Ruido</i>           | 30dB               | 32dB               | 34dB               | 40dB               | 42dB               | 45dB               |  3000K   4000K   6000K |

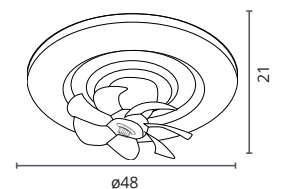





# Panel

Plafón



Versión con luz - 6 *aspas*  
Versão com luz- 6 *palas*

REF. DG-8598 LUZ | Blanco *Branco*



Versión sin luz - 3 *aspas*  
Versão sem luz - 3 *palas*

REF. BPC-60 | Blanco *Branco*

**i** Rejilla giratoria  
*Grelha rotativa*

+ INFO

- ABS+PP+PC
- 1/2h
- 6 *aspas palas*
- 3 *aspas palas*

|                                  | 1                  | 2                  | 3                  | LED                   |
|----------------------------------|--------------------|--------------------|--------------------|-----------------------|
| CONSUMO<br><i>Consumo</i>        | 20W                | 25W                | 30W                | 66W                   |
| RPM<br><i>RPM</i>                | 980rpm             | 1230rpm            | 1340rpm            | 5400lm                |
| FLUJO AIRE<br><i>Flujo de ar</i> | 1500m <sup>3</sup> | 1800m <sup>3</sup> | 2100m <sup>3</sup> | 230 V ~ 50 Hz         |
| RUJIDO<br><i>Ruido</i>           | 45dB               | 46dB               | 48dB               | 3000K   4000K   6000K |

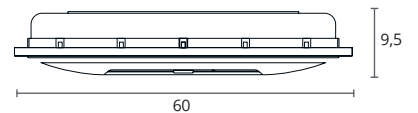



**Modulo LED espiral con imanes**  
*Módulo LED espiral com Ímanes*



**REF. KIT ESPIRAL LED+DRI**  
 Blanco *Branco*

| LED                     |
|-------------------------|
| 💡 72W                   |
| ☀️ 6480lm               |
| ⚙️ 230 V ~ 50 Hz        |
| 🌈 3000K   4000K   6000K |



**REF. KIT ESPIRAL LED**  
 Blanco *Branco*

| LED                     |
|-------------------------|
| 💡 72W                   |
| ☀️ 6480lm               |
| ⚙️ 230 V ~ 50 Hz        |
| 🌈 3000K   4000K   6000K |



**REF. KIT ESPIRAL LED MINI**  
 Blanco *Branco*

| LED                     |
|-------------------------|
| 💡 48W                   |
| ☀️ 4800lm               |
| ⚙️ 230 V ~ 50 Hz        |
| 🌈 3000K   4000K   6000K |



# Accesorios

1

Mando a distancia y controlador para ventiladores con motor DC y regulación de intensidad de luz  
Kit comando remoto e controlador para ventoinhas com motor DC e regulação da intensidade de luz



REF. KIT MANDO RF DIMMER | Blanco Branco

## Funcionalidades:

- Control de seis velocidades
- Temporizador de 2 y 4 h
- Función Brisa
- Función noche o luz nocturna
- Intensidad de luz regulable
- Color de luz regulable
- Función invierno/verano
- Reset para restablecer el funcionamiento: PAR CODE

## Características:

- Controle de seis velocidades
- Temporizador de 2 e 4 horas
- Função brisa
- Função de luz noturna
- Intensidade de luz ajustável
- Cor da luz ajustável
- Função inverno/verão
- Redefinir para restaurar a operação: PAR CODE

2

Mando a distancia y controlador para ventiladores con motor DC  
Kit comando remoto e controlador para ventoinhas com motor DC



REF. KIT MANDO RF | Blanco Branco

## Funcionalidades:

- Control de seis velocidades
- Temporizador de 1,2 y 4 h
- Función Brisa
- Función invierno/verano
- Reset para restablecer el funcionamiento: FAN/OFF

## Características:

- Controle de seis velocidades
- Temporizador de 1,2 e 4 horas
- Função brisa
- Função inverno/verão
- Redefinir para restaurar a operação: FAN/OFF



Escanea QR para instrucciones de RESET de los mandos  
Leitura QR para instruções de RESET dos controladores

# Elige tu ventilador

Escolha a sua ventoinha

## Tamaño

Tamanho

El tamaño del ventilador se verá influido por el área de la estancia. Cada formato S, M y L ayudarán a encontrar el más idóneo para cada espacio.

A área da zona onde vai colocar a sua ventoinha irá influenciar o tamanho da ventoinha a escolher. Os formatos S, M e L ajudarão a encontrar a ventoinha mais adequada para cada espaço.

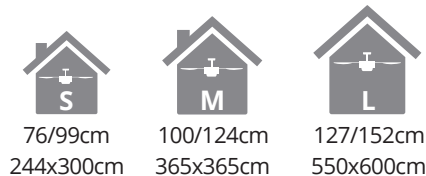

## Tipo de Motor

Tipo De Motor

Según el tipo de motor nos encontraremos con distintas funcionalidades y velocidades: un **motor AC** (corriente alterna) o un **motor DC** (corriente continua). El **motor DC** aporta un ahorro de energía (hasta un 70%) y una baja sonoridad.

Conforme o tipo de motor, encontraremos diferentes funcionalidades e velocidades: um **motor AC** (corrente alternada) ou um **motor DC** (corrente contínua). O motor DC proporciona uma poupança de energia (até 70%) e baixo ruído.

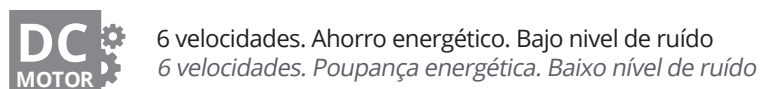

## Flujos y orientación aire

Modo Fluxos ar e orientação/modos

El **modo verano**: trabaja con las capas bajas de aire frío, haciendo que se distribuyan por todo el espacio. El **modo Invierno**: trabaja con las capas altas de aire caliente ayudando a que se distribuyan por toda la estancia.

A mudança da direção de rotação da ventoinha permite um controlo da uniformização térmica pretendida: modo verão (funciona com as camadas inferiores de ar frio) e modo Inverno (funciona com as camadas superiores de ar quente).

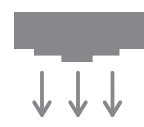
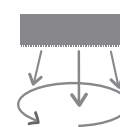
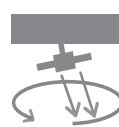
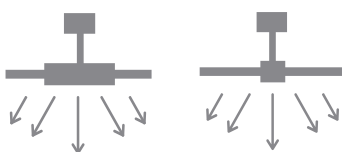
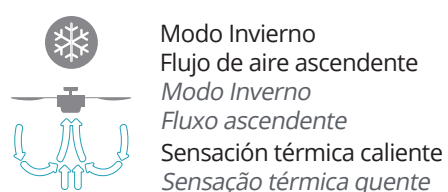
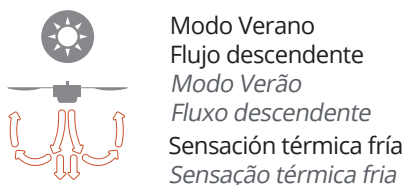



# Guia de iconografía

## Guia de iconografía



Tecnología LED  
*Tecnologia LED*



Material  
*Material*



Modo Verano  
*Modo Verão*



Información de la fuente de luz  
*Informação da fonte de luz*



Aspas  
*Palas*



Función de memoria  
*Função de memória*



Voltage  
*Tensão Nominal*



Control remoto  
*Comando remoto*



Bluetooth  
*Bluetooth*



Cantidad de Luz  
*Quantidade de Luz*



Función RGB  
*Função RGB*



Función altavoz  
*Função altifalante*



Intensidad de la luz regulable  
*Intensidade da luz regulável*



Modo Brisa  
*Modo Brisa*



Aplicación Movil  
*Aplicação Móvel*



Bombilla Led incluida  
*Lâmpada Led incluída*



Flujo de aire direccional  
*Fluxo de ar direcional*



Temporizador  
*Temporizador*



Temperatura de la luz:  $\leq 3200K$   
*Temperatura da luz:  $\leq 3200K$*



Rejilla giratoria  
*Grelha rotativa*



Función OFF 1Min  
*Função OFF 1Min*



Temperatura de la luz:  
3200K-5000K  
*Temperatura da luz:  
3200K-5000K*



Dos tamaños de tijas  
*Dois tamanhos de tubos*



Modo Ahorro  
*Modo Económico*



Temperatura de la luz:  $> 5000K$   
*Temperatura da luz:  $> 5000K$*



Motor DC  
*Motor DC*



Modo Nocturno  
*Modo Noturno*



Temperatura de la luz regulable  
*Temperatura da luz regulável*



Motor AC  
*Motor AC*



Control por Voz  
*Comando por Voz*

# Contacto

**INTERLUSA—Manfred H. Müller & Ca. Lda**

**[www.interlusa.com](http://www.interlusa.com)**

**CONTÁCTENOS**

Polígono industrial La Negrilla.  
Calle celulosa 31.  
41016, SEVILLA, ESPAÑA

+34 854 809 462

[jose@interlusa.com](mailto:jose@interlusa.com)

**CONTACTE-NOS**

Estrada Interior da Circunvalação, 12477  
4100-178 PORTO, PORTUGAL

+351 226 102 393

[luz@interlusa.com](mailto:luz@interlusa.com)

© COPYRIGHT INTERLUSA 2025

TODOS LOS DERECHOS RESERVADOS.  
IMÁGENES MERAMENTE ILUSTRATIVAS. NO NOS HACEMOS RESPONSABLES DE LOS ERRORES TIPOGRÁFICOS.  
TODOS OS DIREITOS RESERVADOS.  
IMAGENS MERAMENTE ILUSTRATIVAS. NÃO NOS RESPONSABILIZAMOS POR ERROS TIPOGRÁFICOS.





[www.interlusa.com](http://www.interlusa.com)

**Interlusa**<sup>®</sup>  
Manfred H. Müller & Ca Lda